

The background of the cover is a high-angle, close-up photograph of a paper mill's machinery. It shows a complex arrangement of rollers, belts, and structural beams, all bathed in a warm, golden-yellow light. The perspective is looking down the length of the machinery, creating a sense of depth and scale. The overall texture is industrial and detailed.

# twogether

Paper Technology Journal

**Interview:**  
World record in Braviken.

**A special event:**  
Hosting the european paper  
industry.

**News from the Divisions:**  
“Pole position” for Voith Sulzer  
shoe presses.

**Corporate News:**  
Joint Venture in China –  
Liaoyang.

**Newspaper hoaxes:**  
The ingenuity of journalists.

**4**

## Contents

Foreword	1
<b>Interview:</b>	
World record in Braviken	2
<b>A special event:</b>	
Hosting the european paper industry	10
<b>News from the Divisions</b>	
Stock Preparation: Screening – a tool for stickies removal	22
Stock Preparation: Stickies removal in flotation	30
Paper Machinery: “Pole position” for Voith Sulzer shoe presses	34
Paper Machinery: Web and tail transfer systems in board and packaging paper machines	41
Finishing: Janus – a new technology for old calenders?	49
Finishing: Calender rebuild to Janus – economical aspects	56
Service: Potential in Europe	61
<b>Corporate News</b>	
China: Joint venture in China – Liaoyang	66
Great Britain: A new home for Nipco	70
USA: Voith Sulzer Paper Technology – rooted in the history of North American papermaking	72
<b>Newspaper Hoaxes:</b>	
The ingenuity of journalists	78

*Cover picture:  
Janus calender rolls (see page 49).*



Hans Müller,  
President and CEO,  
Voith Sulzer Papiertechnik GmbH & Co. KG

*Dear customers, dear readers!*

*Paper and board are and remain important communication media, in spite of all the diverse electronic media available. The demand for paper and board is increasing annually at a rate of 2.3 to 2.5 percent and all the leading experts are of the opinion that this trend will continue well into the 21st century. One region in particular exhibits a double-digit rate of growth compared with the rest of the world: Asia, with its expanding economy. This development is confirmed both by the excellent overall order situation for Voith Sulzer Paper Technology's third business year and also in our specific deliveries to the Asiatic region. Compared to our company's first two years of business, in which the proportion of orders from the Asiatic region was approximately 20 percent, we expect a distinct increase for the current year.*

*Not surprisingly it is the innovative, forward-looking companies and regions in which our products and services are most successful. Wherever there is progress, leading-edge technology is at the forefront. The most recent example is the PM 53's world record in Braviken with 1672 m/min or more than 100 km/h in continuous operation – a success which points the way forward. For more information, please read the report on the following pages.*

*In the light of an increasingly global market it is quite clear just how important it is to improve the level of cooperation and to arrive at even better technological solutions and efficiency; this was confirmed during the first customer congress of our Stock Preparation Division in Ravensburg (see page 10). Only by working together with our customers and through the exchange of concepts, ideas and visions will it be possible to create meaningful and practical improvements. We hope that you will find many points of interest in our latest twogether customer magazine to further this dialogue.*

*Yours sincerely,*

A handwritten signature in blue ink, which appears to read "Hans Müller". The signature is fluid and cursive.

Hans Müller

Olle Svensson and Per Bjurbom  
(bottom): "We have invested in the  
right technology. PM 53 is quite simply  
a very, very good paper machine."



**WORLD REC**

**IN BRAVI**





# ORD

# KEN



With this “mile-a-minute” newsprint machine in Braviken, Voith Sulzer has set a world record yet again: in February 1997, the machine operated at a mean speed of 1672 m/min – more than 100 km/h – for more than 24 hours. Peak speeds reached 1703 m/min.

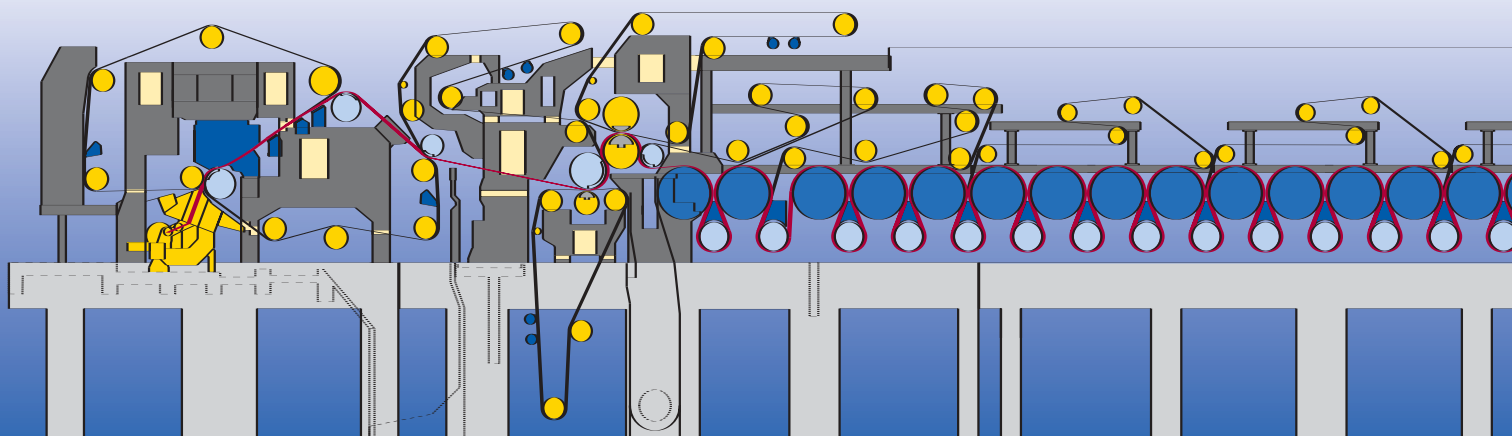

*Marion Nager,  
Corporate Marketing,  
interviewed Braviken  
Mill Manager Olle  
Svensson and PM 53  
Production Manager  
Per Bjurbom.*

*MN: Why did you make this large investment in Braviken?*

OS: These days we have to offer our customers a wide variety of paper grades. Let me tell you something about the background:

Holmen Paper has always been a big newsprint producer.

In recent years we have been very successful in upgrading to improved newsprint qualities, mainly in our Hallsta mill, particularly with regard to brightness. Apart from this, our output of newsprint and telephone book paper has steadily grown. Today are Europe's biggest producer of telephone book paper.

To start with we managed this growth without investing in new machinery, until at the beginning of the nineties our standard newsprint capacity was not enough to meet demand. Our decision for the new PM 53 then not only gave us additional capacity of 300,000 tpa, but also allowed further developments toward improved newsprint production.

Naturally our final target was also higher profitability through economies of scale with larger production facilities.

*MN: What was the order of magnitude of this investment?*

OS: Total investment for the entire production plant amounted to 2040 billion SEK. This included a complete paper machine, two winders, a wrapping line, extension of our stock preparation with a second deinking line, and a new TMP production line.

*MN: What kind of raw materials do you use?*

OS: Currently we are using a mixture of 40% DIP and 60% TMP on PM 53. 40% of the waste paper furnish comes from Sweden, and the rest from Norway, Germany and Britain.

*MN: What paper grades do you manufacture on PM 53, and how flexible is your production programme?*

OS: We think our PM 53 gives us the greatest possible flexibility – we can make a whole range of different newsprint type grades.

We started off of course with standard newsprint paper at 45 g/m<sup>2</sup>, but it has become very clear already that PM 53 is also an excellent machine for the lower basis weights now in growing demand on European markets. We have already produced 40 g/m<sup>2</sup> and 42 g/m<sup>2</sup> grades suc-

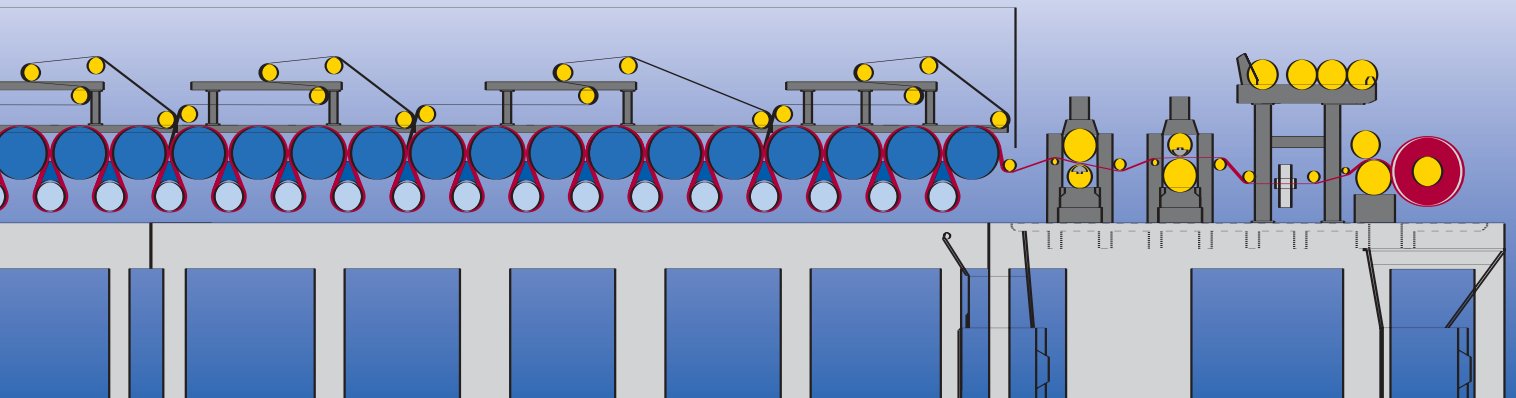

#### Technical data of PM 53

Wire width	9650 mm
Cut web width	8950 mm
Rated operating speed	1800 m/min
Basis weight range	40-48,8 g/m <sup>2</sup>
Capacity	986 t/24 h

#### Features

GapJet*
Headbox with ModuleJet*
DuoFormer* CFD
Gap-Former with JetCleaner
Duo-Centri 2 press section with NipcoFlex shoe press, blind-drilled QualiFlex press sleeves and DuoSteam blow box
Single-tier dryer section with DuoStabilizers and DuoCleaner dryer fabric cleaning
Soft calenders: (2 x 1 nip) with Nipcorect rolls
Pope reel with Center Wind
2 DuoRollers

cessfully, and are currently considering making even thinner grades down to 34 g/m<sup>2</sup>. With the soft calender on PM 53 we shall also be in the position to produce rotogravure printing papers, because it

allows line forces up to 380 kN and temperatures up to 200°C. We still have to prove this in practice, however. The degree of flexibility of course also depends on variations in furnish qualities.

*MN: What made you choose Voith Sulzer Paper Technology for your project?*

OS: With PM 51 and PM 52, we have of course already had two large and highly efficient Voith machines in Braviken. So in 1988 we started discussions with Voith on new technology to keep us competitive well past the turn of the millennium.

What we wanted was a paper machine with highest possible production efficiency while keeping operating costs as low as possible. And we also wanted the best papermaking system on the market; a press section comprising only 3 nips, with no open draw and high dryness, a completely closed web run through the entire dryer section, and a soft calender.

We soon came to the conclusion that a DuoFormer CFD would be the best solution. In the press section nowever there seemed to be only one way of reaching

# HOSTING THE EUROPE



*Hans Müller, Chief Executive Officer of Voith Sulzer Paper Technology (photo left), welcomed the guests on the first evening. Karl Turobin-Ort, Vice President Stock Preparation Systems, Dr. Lothar Pfalzer, Head of the Voith Sulzer Stock Preparation Division, and Herbert Holik (picture above, from left to right), opened the programme of specialist papers.*



# EAN PAPER INDUSTRY



The Stock Preparation Division had sent out invitations and some 250 experts from 15 European countries attended the first Customer Conference to be held by Voith Sulzer Paper Technology since the companies merged in this business area.

The conference took place under a radiant blue sky and at spring temperatures in Friedrichshafen on Lake Constance, Germany. 16 reports on the general topic of "Preparation of Waste Paper as a Valuable Secondary Raw Material for New Papers in a Wide Range of Qualities" were the highlights of this event.

Dr. Lothar Pfalzer (right) presented the structure (Fig. 1) of Voith Sulzer Paper Technology, with particular reference to the Stock Preparation Division and its COC (Centre of Competence) in Ravensburg.



In his address of welcome at the start of the conference programme, Dr. Lothar Pfalzer, Head of the Voith Sulzer Stock Preparation Division, drew attention to the long-standing and traditional links between Ravensburg and the paper industry, as one of the oldest papermaking centres in Europe with a history dating back 600 years. He laid emphasis on the fact that, since the merger of the Voith and Sulzer Paper Technology operations, many of the synergy objectives have already been attained. The highly satisfactory progress of business confirmed the decision to merge the two tradi-

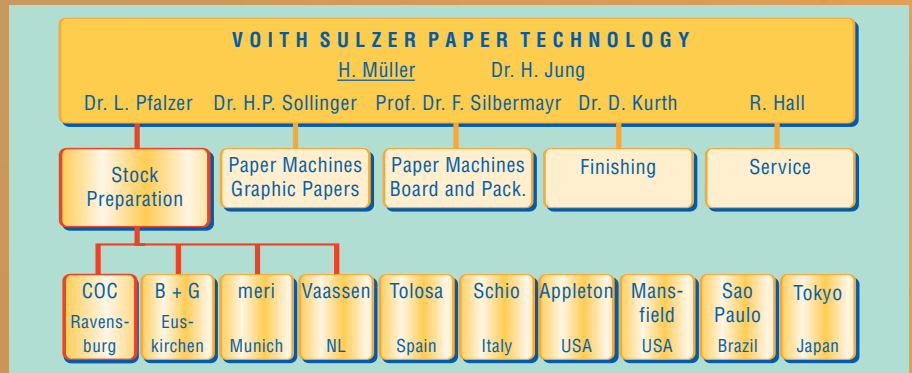

tional companies.  
 “We wish to thank you here and now for remaining loyal customers in this merger period, despite the problems encountered. Your confidence is both an encouragement and an obligation for us. Our combined resources now offer you a wide range of benefits. For instance, with the merger we have combined both research expenditures with no cutting corners”.

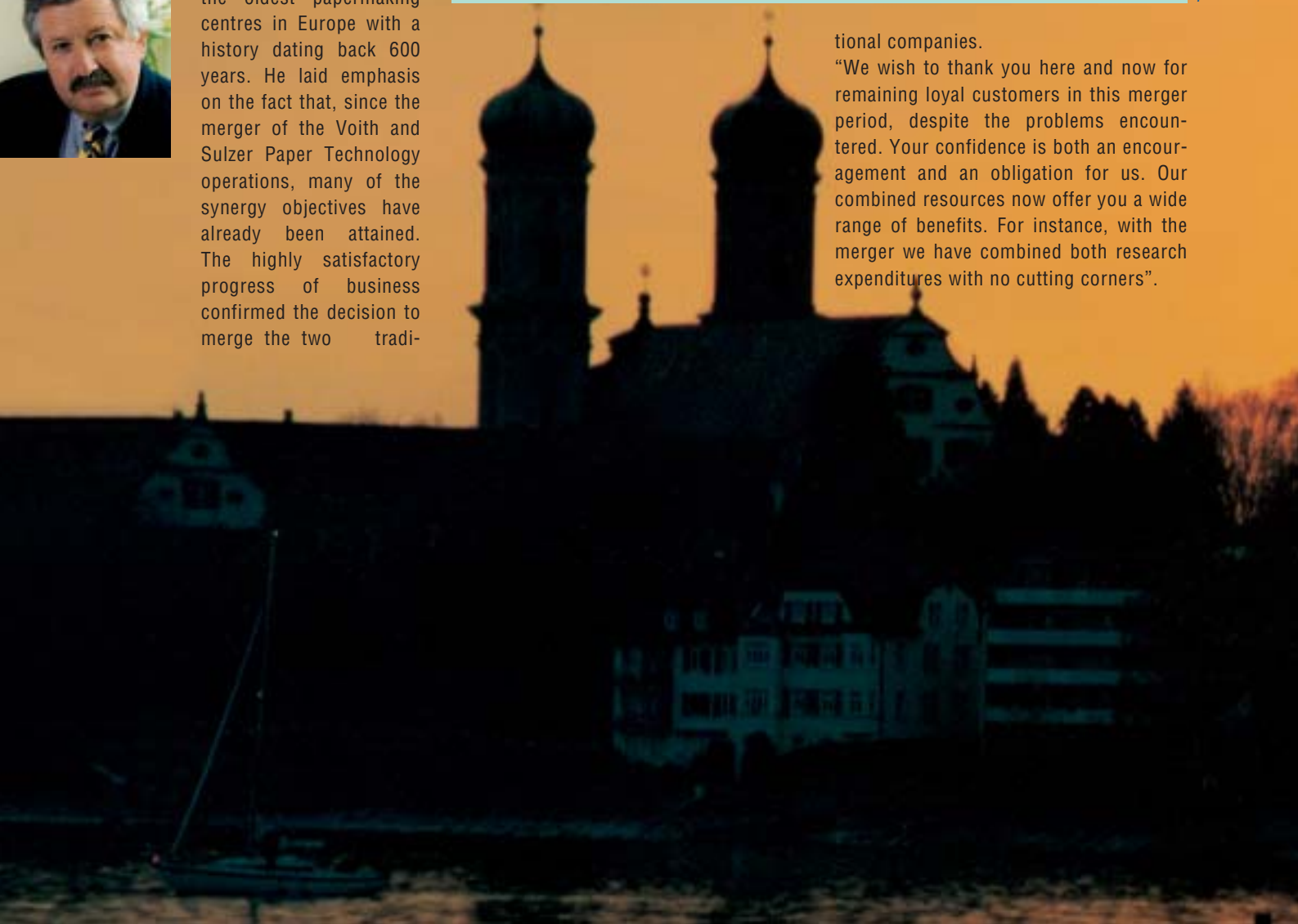



*Welcome relaxation after the concentrated presentation of technical information was*



Where does the young company stand today with its extensive experience in the field of stock preparation? The first customer conference brought a convincing answer to this question. Dr. Pfalzer began by presenting the structure of the company with particular emphasis on stock preparation (Fig. 1). Stock preparation is one of the five divisions of Voith Sulzer Paper Tech-

nology. Management of the various facilities with their independent business units for stock preparation in Europe, America and Asia is now controlled from Ravensburg, the headquarters of Voith Sulzer Stoffaufbereitung GmbH & Co. KG. Research and development, patents and licencing as well as marketing functions, serving all the divisional sites, are also centralized in Ravensburg for all worldwide operations. The special structure of



Fig. 2:  
From woodyard to packaging the finished paper,  
Voith Sulzer Paper Technology supplies  
everything from a single source.

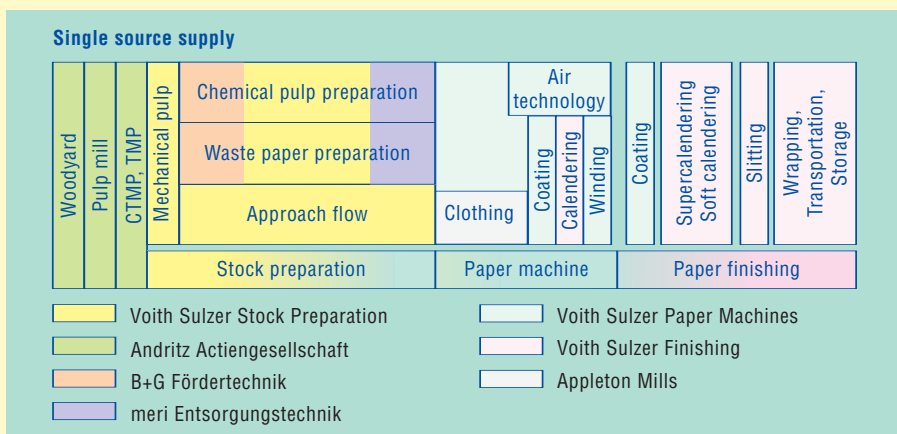

customer expectations had been satisfied in the accustomed manner in the recent past – due to the merger of the Voith and Sulzer Stock Preparation Divisions to form a single division at the Ravensburg facility. 20 tons of documents and 180,000 drawings had to be moved, to say nothing of production machinery and stocks of spare parts. This phase is now behind us. “The new Voith Sulzer service can be put to the test”. Service to customers comprises telephone advice around the clock, fast on-site intervention, short delivery periods because supplies of many wear parts and spares are held

the division – concentration on the one hand and global diversification and presence on the other – ensures that customers can find a qualified Voith Sulzer discussion partner anywhere in the world, whether for complete plants or individual machines. Fast and expert service assistance is readily available. After all “stock preparation is the foundation of successful papermaking”.

### Sales and nearness to customers

Under this heading, Karl Turobin-Ort went on to discuss the worldwide growth of paper production from the present figure of 280 million tons per year to around 450 million tons by the year 2010. He made it clear that this growth will be unevenly distributed; in the immediate future, it will be concentrated primarily on Asia where massive investments are being made in high technology machinery. Asia is now advancing to become a major power on the world paper market. From the European angle, it is important to follow carefully the influence of this Asian pressure on the

global structure of our industry and on the familiar cycles in our industrial development. With its worldwide market presence and familiarity with the global paper industry, Voith Sulzer Paper Technology offers its European customers an intensive dialogue over their investments, from initial talks to final implementation. Apart from know-how, Voith Sulzer Paper Technology with its partners is able to deliver “everything from a single source”, not just in stock preparation but also from “the woodyard right through to packaging the finished paper”. We believe this will prove to be a particularly valuable asset (Fig. 2). Quoting the example of Voith Sulzer’s six European contact partners in Sweden, France, the Netherlands, Great Britain and Spain, together with the service and spare parts centres, Karl Turobin-Ort explained what the division understands today by nearness to its customers.

### How does our service function?

This question was answered by Werner Brettschneider who conceded that not all



Fig. 3:  
"The new Voith Sulzer Service can be put to the test".

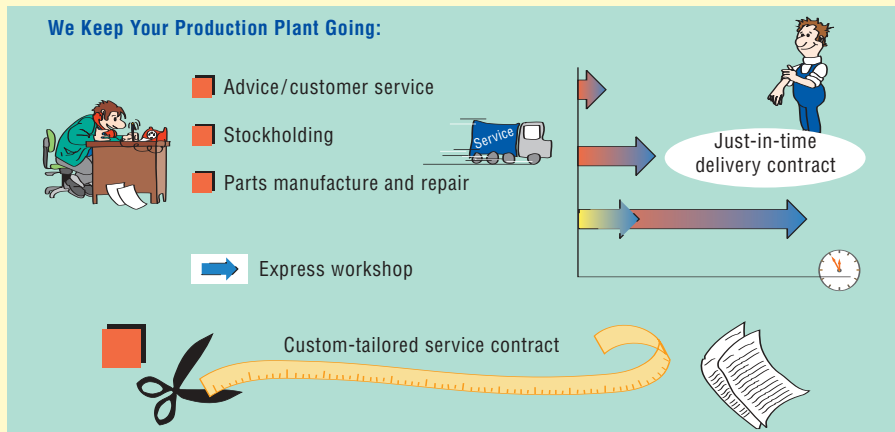

in stock and the newly fitted-out express manufacturing facility for emergencies. A hot line has been set up to answer particularly urgent problems. In addition, tailored solutions can be offered to customers to safeguard production efficiency, for instance, call-off and maintenance contracts or special rebates (Fig. 3). In the service area, nearness to customers is the aim, too. In Europe and beyond its borders a dense network of own companies, representations, licensees and group companies has been set up.

*The two-day event was rounded off by a visit to the recently extended Research and Technology Centre in Ravensburg with a comprehensive exhibition of state-of-the-art system components, particularly for waste paper preparation.*



### Stock cleanliness – an important objective in stock preparation

With this presentation, Herbert Holik, Head of Voith Sulzer Stock Preparation Research and Development, opened the series of technical papers. Stickies and the optical impression are important criteria today in terms of product quality and efficiency for papermakers of both white and brown grades. The more exacting requirements placed on cleanliness not only demand more complex processing systems but also equally exacting measuring technology – for instance to ensure adequate statistical reliability of

The following is a summary by Herbert Holik of all the technical papers presented during the Stock Preparation Division's Customer Conference.

On request, the full text of the contributions with all illustrations is available directly from Voith Sulzer Stoffaufbereitung GmbH & Co. KG, Ravensburg.



The author:  
Herbert Holik,  
Research and  
Development  
Stock Preparation  
Division

the measured values. Holik highlighted the existing difficulties. No method is yet in view for quantitative measurement of microstickies.

The situation is somewhat better with the measurement of macrostickies. Admittedly, no generally acknowledged measuring technique exists as yet, so that statements on absolute values and degrees of efficiency must first be examined to determine how they are arrived at.

However, Voith Sulzer Stock Preparation now offers an improved measuring method representing real progress in

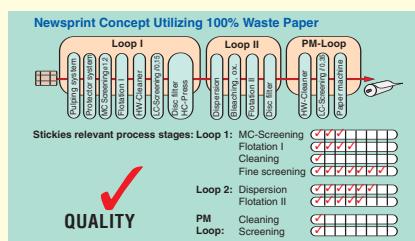

“Stickies – a challenge for the entire process technology”, was the title chosen by Michael Schwarz for his presentation.

He began with the wide range of substances found in the papermaking process. As a function of the different particle sizes, he explained the corresponding technical processes by which undesirable particles can be removed from the suspension. In addition to mechanical separation of macrostickies in the stock flow, fine tuning of chemical additives in the entire system, optimization of water management and the sep-

As a guest speaker on behalf of Haindl Papier, Germany, Manfred Geistbeck had prepared his presentation entitled “Stickies removal in flotation” jointly with Horst Wiese, also of Haindl Papier, as well as Martin Kemper and

accuracy, practicality and economy. The procedure is also faster than previous Voith Sulzer methods. Herbert Holik, who chaired the conference and led the discussions, stressed the importance of an intensive exchange of information between papermakers and suppliers at a time when the pace of developments is becoming faster and faster. The customer conference objective was to provide information on the “tools” which Voith Sulzer Stock Preparation can offer its partners today. At the same time, Holik stressed the need for early indications of future requirements by the paper industry to secure the appropriate ongoing development of these tools.

aration of microstickies from the filtrate flows are the main tools used to control stickies. Quoting one example of a process, he illustrated the steps for controlling stickies in stock preparation for newsprint made from 100% recycled paper. Many members of the audience perhaps heard for the first time that flotation II after dispersion makes an important contribution to reducing macrostickies. The benefit of dispersion is not solely that the stickies can be rendered harmless by reducing their size, but that this process step apparently permits better flotation of the stickies. However, screening still remains the most important method of removing stickies.

Quoting the example of two testliner system concepts, he went on to show that single loop systems with screening in the approach flow represent a cost-effective solution. On the other hand, the possibility of choosing the rather more complex two loop system should be carefully considered, too. Stock storage, separate loops and locating the screening stage up front in the stock preparation ensures high paper machine productivity.

Thomas Martin of Voith Sulzer. Laboratory tests have shown that stickies removal in the flotation stage of the Schongau waste paper preparation plant can be further enhanced. See page 30.

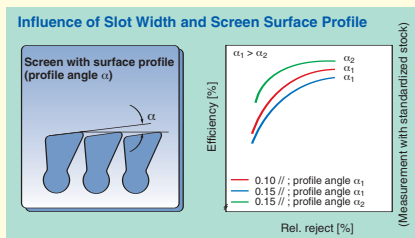

The next three contributions dealt with **“Screening – a tool for stickies removal”**. As the first speaker, **Samuel Schabel** examined the **“fundamentals”**. Size, geometry and deformability of the stickies have a decisive bearing on their suitability for removal. The design of screen housing, rotor and basket determine fluid dynamics and the forces applied to the suspension.

For particles with at least one dimension smaller than the screen basket openings, the removal probability reduces with each screen basket contact. One important result of many studies was that as regards screening efficiency, the slot width must always be seen in context with the basket surface profile. For instance, with a slot width of 0.1 mm, screening efficiency is, in fact, lower than with a slot width of 0.15 mm, if at the same time the profile angle is reduced. With easily deformable stickies, removal efficiency is

lower than with more rigid particles. Removal efficiency decreases with increasing shear and compression forces in the screen.

For these sensitive screening tasks, the screens should be run at low consistencies, moderate rotor speeds and low pressure differences across the screen basket. Schabel used two diagrams to emphasize the fact that the mean screen throughflow velocity cannot be used as a criterion for evaluating different types of screens.

The diagrams showed the measured screen throughflow velocities during one rotor revolution for two different rotors. Both the local peak values of the flow velocities – up to a factor of ten times the mean value or more – and the shape and length of the pressure and vacuum phases showed wide differences.

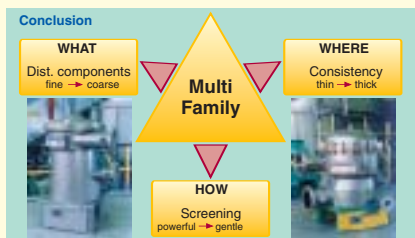

In the second presentation in the trilogy **“Screening – a tool for stickies removal”**, **Reimund Rienecker** dealt with the subject of **“machines”**. He stressed the importance of carefully matching the individual components and their combination to the particular screening task.

For instance, velocity, together with pressure and vacuum pulses differ widely from one rotor to another (foil, step, bump and lobed rotors) as does their throughput limit, screening efficiency for foreign substances in general and for stickies in particular. Another important factor is the influence which the slot width has on the thickening factor (i.e. the ratio of overflow to inlet consistency): diminishing slot widths lead to an over-proportional rise in the thickening factor. Minimum slot widths of 0.1mm, which are the subject of great controversy today, are particularly sensitive: even the smallest deviations in slot

width or in profile angle (e.g. caused by wear) result in significant changes in plant operating conditions and in technological results. Operating reliability, screening efficiency and specific throughput are significantly increased if the flow is uniform over the entire area of the screen basket. This is achieved by the “Multi-Family” with its flow-optimized housing and the “fish mouth” shape of the accepts outlet.

The Multi-Family includes the MultiSorter, the MultiFractor and MultiScreen. Careful selection and combination of the individual modules ensures a tailored machine for every screening task and production capacity. The range covers high and low consistency screening, applications in stock preparation and in the approach flow as well as fractionating and screening tasks in mechanical and chemical pulp production.

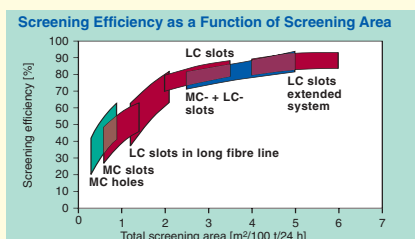

**Peter Schweiss** was the third speaker on the topic of **“Screening – a tool for stickies removal”**. He discussed **“systems”**. From the various machine and system parameters, a whole range of general concepts can be derived to handle the different screening tasks, e.g. slot screening for medium and low consistencies, slot screening in the approach flow representing the only use of fine screening or in addition to that in stock preparation. In a summary, the various arrangements of screening stages (forward, full cascade, partial cascade and series) were compared. The thickening factors in a screening

system depend very largely on the slot width. This was illustrated by the example of slot widths of 0.1 mm and 0.15 mm in a system with two and three stages. A size comparison of the slot opening of a C-bar screen basket with the fibres and fibre bundles of a wood-containing deinking stock illustrated this conclusion.

Various system variants for a deinking plant were also discussed, with particular reference to their screening efficiency: low consistency slot screening, as favoured by Voith Sulzer, medium consistency slot screening, medium

consistency followed by low consistency slot screening and the series variant with low consistency slot screening. An overview of screening systems in brown stock plants was given. This included the recommended low consistency screening and the different designs of medium consistency slot screening, medium consistency and subsequent low consistency slot screening with fractionation as well as low consistency slot screening in the approach flow. In each case typical layouts and the resultant screening efficiency were presented. With brown stock, effective deflaking is necessary to minimize fibre losses. With high dirt concentrations, intermediate

screening using a Rejectsorter or Combisorter must be installed to protect the deflaker against excessive wear.

Fine screening in the low consistency range offers the benefit that the screen baskets with fine slot widths are more effectively protected against wear, since the particles causing wear can be removed more efficiently. The fact that improved screening efficiency generally also necessitates greater expenditure was illustrated by showing screening efficiency plotted over the required total screen area of the complete screening system.



In his paper entitled **“Dispersion – an important process stage for reducing stickies problems”**, **Wolfgang Mannes** called attention to a trend in the brown stock sector. The first plants with low consistency slot screening without dispersion are already operational.

However, dispersion is likely to continue to be justified in certain market segments because of the variety of raw materials and the different product criteria such as optical impression, hygiene and strength.

For white products, the trend is now towards low consistency screening with slot widths of 0.1 mm to 0.15 mm. In all cases, residual stickies are extremely detrimental to product quality and paper machine runnability. That is why dispersion will no doubt remain indispensable in future for white paper production. How does the disk dis-

perger or kneading disperger handle stickies and what are the best operating conditions for them?

In extensive tests, both in the Ravensburg R & D facility and in commercial operation, it was found that the disk disperger is more efficient than the kneading disperger as far as stickies are concerned. Despite intensive studies, it was impossible to show that stickies are agglomerated by the kneading disperger or by other kneaders, as has frequently been argued in the industry.

As to the effectiveness of stickies treatment, this increases with stock consistency and temperature; a specific dispersion energy of 60 to 80 kWh/t is normally sufficient. Cast fillings are beneficial and a maximum peripheral speed of 50 to 60 m/s is optimum. This avoids unnecessary wear problems.

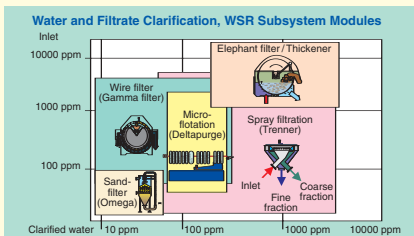

The contribution on **“Microstickies – troublemaker in water loops”** by **Lucas Menke** concluded the papers on stickies. Menke is the Managing Director of Meri Entsorgungstechnik, Munich, a joint venture of Meri Anlagentechnik and Voith Sulzer. He explained that stickies problems necessitate a detailed examination of the water system. Micro-stickies are evenly dispersed in the water. Their concentration depends essentially on the specific water consumption of the process. Initial chemical treatment must first agglomerate microstickies into flocs.

They can then be removed in the microflotation system. Filtrate flows with a minimum load of any other solids should be chosen to keep the chemicals consumption and losses in valuable solids as low as possible. A recipe on how to select the best chemicals and a summary and assessment of

the different dosing concepts and chemicals were given. Upgrading results taking the example of a newsprint mill were presented.

The importance attached nowadays to optimum water, sludge and reject treatment was explained. First, typical WSR (water, sludge, reject) sub-systems were presented for a deinking plant and a brown stock preparation plant. The individual components for water and filtrate cleaning and their optimum application depending on solids contents in the inlet and in the clarified water were then explained.

The various machines for sludge dewatering, their capacity and attainable final consistency were described. Finally, the machines for efficient reject handling and reject dewatering were presented.



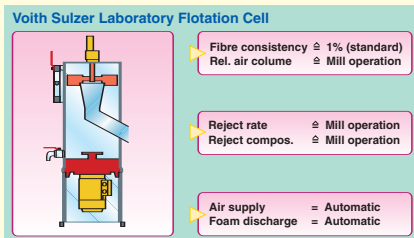

Opening his introduction to the problems of “Optical cleanliness”, **Herbert Holik** defined the criteria for its determination: dirt specks, mottling, brightness and lightness, together with chromaticity values.

Here, too, there are problems with measurements, e.g. in the measurement of dirt specks with different methods measuring different size spectra or the unsolved problem of measuring the

brightness of very grey stocks. Laboratory flotation is generally used to determine the maximum brightness achievable for a particular stock.

Recognizing the importance of laboratory flotation as a standard reference, Voith Sulzer has developed a new laboratory flotation cell, which operates under conditions close to those encountered in practice.

**Effectivity of Process Modules in Removing Disturbing Components** optical

Process module	Screening	Flotation	Washing	Centrif. heavy weight	cleaning light weight	Dispersion	Bleaching oxid. red.
Disturbing components							
Conventional printing inks	—	●	○	○	○	●	○
Non-impact inks	○	●	—	○	○	●	—
Lacquers	○	●	—	○	○	●	—
Flexo inks	—	○	●	—	○	—	—
Fibres with undetached inks	—	—	—	—	—	●	○
Unbleached fibres	—	—	—	—	—	—	●
Coloured fibres	—	—	—	—	—	—	●

Legend: ● High, ○ Medium, ○ Low, — No effect

**Harald Selder** entitled his presentation “Improving the cleanliness of secondary fibre stocks”. He examined the optical, chemical, colloid-chemical and microbiological cleanliness. These three factors have assumed very great importance today, in food packaging and in other areas. He began by illustrating the size ranges of optical inhomogeneities and the efficiency of process modules in eliminating them.

Flotation is the leading technique for this purpose. However, dispersion, too, makes an important contribution by reducing the size of printing ink specks to below the visibility limit and making toner particles floatable. Quoting the example of a three loop system, he showed how a secondary fibre raw material similar to chemical pulp quality can be produced from office waste. A list of detectable chemical contents with an indication of their origin and problems created by them was

followed by indications as to which process steps are the most successful for their removal. The main process step here is washing with suitable treatment of the filtrate, and flotation. A second list, this time of relevant microorganisms, described their effect on the paper production process and on the consumer. An integrated process module for sterilization was proposed here.

To eliminate problems caused by inadequate colloid-chemical cleanliness, these substances are nowadays frequently fixed on the fibres using polymer fixing agents and leave the production process with the finished product. However, it is strongly recommended that the stock be dewatered to a high consistency ahead of the paper machine. The colloidal substances should then be removed from the filtrate.



In his presentation “Flotation deinking – a key technology for brightness and cleanliness”, **Herbert Britz** began by describing the various principles in flotation and their resulting benefits and drawbacks.

For instance, centrifugal force in flotation achieves higher brightness than conventional flotation cells because the spectrum of particle sizes to be removed is moved downwards. On the other hand, the range of the spectrum is considerably reduced so that the removal efficiency with larger particles falls dramatically.

The EcoCell, as a synthesis of the former E cell (Voith) and CF cell (Sulzer) combines the operating and technological benefits of both its predecessors. The technological benefits come into play in both primary and secondary flotation.

Here, high dirt speck and stickies reduction, a considerable increase in brightness as well as

distinct reduction in fibre losses in the secondary stage are achieved. Controlling the overflow from the secondary stage ensures economic fillers removal from the suspension. The largest plant delivered to date is designed for a capacity of 675 t/24 h.

The heart of the EcoCell is the 4 stage suction micro-turbulence generator. It permits a high flow ratio of process air and suspension and includes areas of different microturbulence, thus generating a wide spectrum of air bubble sizes. This in turn results in a broad size spectrum of particles which can be removed.

A retrofit kit is offered for converting existing E cells or tubular cells to the EcoCell specification. This improves the technological results or increases the capacity of existing plants, while fibre losses and energy consumption can be reduced.



“Dispersion – the process stage for improving optical properties” was the title of the presentation by **Volker Niggli**. He explained the wide range of tasks assigned to the dispersion system: residual dirt specks and stickies must be rendered dispersible or flotateable, printing ink still adhering to the fibres must be detached, bleaching agents mixed in, catalases destroyed, the germ count reduced, fibres treated technologically and in special cases coating grit has to be dispersed. The disk disperser and kneading disperser are suitable for these tasks. Both machines are highly efficient as far as reduction of dirt specks is concerned. For conventional printing inks, the disk disperser has slight advantages, while the kneading disperser is better for laser printing particles.

The dispersion effect of both machines rises with increasing specific energy. In the disk disperser, this is determined in advance by the choice of fillings and consistency and is controlled by adjusting the gap between the fillings. With the kneading disperser, the number, arrangement and geometry of the teeth as well as consistency influence the specific energy absorbed. This can be readily adjusted by a throttle on the outlet

side. Both machine types are designed for a maximum motor load of 2,500 kW with a maximum production of 700 t/24 h each. Only the disk disperser can also be used at temperatures in excess of 100°C. However, for cost reasons heating should be kept to the absolute minimum, as underlined by a diagram of the operating costs from different dispersion units. The higher the process temperature, the greater the reduction in dirt specks in dispersion while breaking length diminishes. The disk disperser is operated at temperatures in excess of around 85°C, while the kneading disperser can also be run “cold” since it treats the fibres more gently, even at lower temperatures.

The disk disperser and kneading disperser are similar in their removal of printing inks and mixing in of bleaching chemicals for increasing brightness. In the summary, attention was drawn once again to the strong points of the two types of dispersers, their typical operating conditions for the individual applications were listed and recommendations given for their use in stock preparation systems.

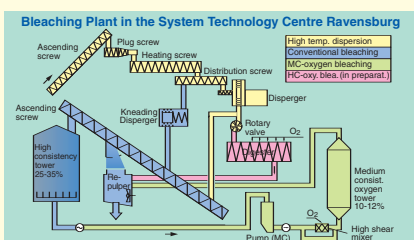

**Volker Gehr** wound up the presentations on the subject of optical cleanliness with his paper entitled “Bleaching of secondary fibre stocks – what can white magic achieve?”.

He indicated as the main task of oxidative bleaching techniques an increase in brightness by lightening the fibres, while reductive bleaching controls chromaticity coordinates and increases brightness by colour stripping. He illustrated the gain in brightness, the general effect, operating parameters and the machines for conventional chlorine-free bleaching of secondary fibres.

Harmful decomposition of the peroxide bleaching agent is caused by heavy metals, catalases, reduction agents and COD. Possible solutions were indicated for each of these problems.

Taking the example of two-stage, oxidative followed by reductive bleaching, a preparation system for upgraded newsprint was discussed and the importance of water loop separation highlighted. The sequence reductive then oxidative bleaching was illustrated by the example of a three loop system to make market pulp grades of equivalent quality to chemical pulp from office waste. In this case, strict water loop separation is vital for the technological success and for good economics. As regards “unconventional” bleach-

ing of secondary fibres with oxygen, typical process parameters and the anticipated results were indicated. Vastly different results occur with wood-containing and woodfree raw materials. Different technological results are obtained when operating modes are employed such as high alkaline charge and simultaneous high temperatures or modes with low alkaline charge and low temperatures with simultaneous addition of peroxide.

For secondary fibre bleaching with ozone, brightness can be increased by up to 20 points, but this effect is confined to virtually woodfree raw materials. On the other hand, ozone is the most effective of all chlorine-free bleaching agents for colour stripping and for deactivating brighteners or to reduce the effect of unbleached kraft fibres.

In the Voith Sulzer R & D plant, conventional bleaching can be performed with peroxide, dithionite and FAS in both the high and medium consistency ranges. Oxygen and peroxide-enhanced oxygen bleaching in the medium consistency range is also possible. A further extension of the plant to include high consistency pressurized bleaching is planned.

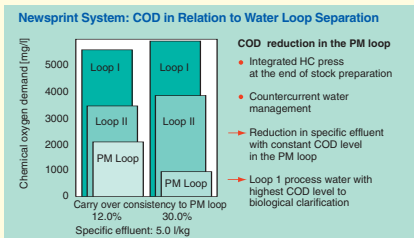

Two papers then specifically dealt with **“Systems”**. The first, by **Dietmar Borschke**, presented the interrelationship between the individual process stages discussed earlier in the day. At the beginning of his paper on **“System designs – a complex puzzle for the entire process technology”**, Borschke defined the different technological objectives for white and brown stock systems. He went on to present a plant concept for upgraded newsprint and illustrated the progress in cleanliness (stickies area, dirt speck area and brightness) right through the process. In the process water loop, the COD was presented as a function of specific waste water discharge. To reduce COD in the paper machine loop, high consistency thickening is recommended at the end of the stock preparation, as well as consequent application of the counterflow principle throughout the water loops. The process water is then removed from the loop with the highest COD (loop 1) level for biological clarification. Plants of this type are operated nowadays with a specific effluent rate of 8 to 10 l/kg and show a COD of around 1,000 mg/l in the paper machine loop. As an example for packaging paper production, a

plant design with a two loop system for the preparation of testliner stock was presented. The change in stickies area and dirt specks was illustrated throughout the process.

A comparison of the more complex two loop system with a lower cost single loop system resulted in the recommendation to choose the two loop system and to operate a screening stage in the approach flow purely as a safeguard measure. With the two loop system, product quality and the process itself are easier to control from both the technological and technical point of view. The higher investment and operating costs are more than offset by improved paper machine efficiency. In conclusion, the following statements were made covering the water loops and specific effluent rates for testliner and fluting systems: closed water loops operate satisfactorily from the point of view of manageable plant conditions and good product quality if around 3 to 4 litres process water per kg finished stock are treated in an integrated biological clarification plant and the resulting COD is less than 10,000 mg/l.

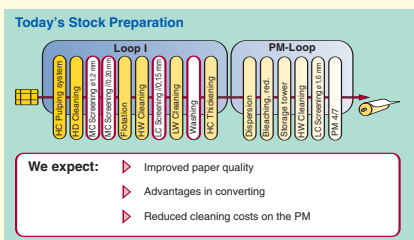

The second guest speaker **Helmut Berger** of Wepa Papierfabrik, Giershagen, Germany, wound up the conference with his contribution **“Leading edge technology for soft products – translating practical experience into system design in a tissue mill”**.

After describing the group’s mills and the Wepa initiative for “recycled paper with a 100% closed circuit”, he defined the reasons for Wepa’s ongoing development work in stock preparation: adaptation to changes in waste paper quality, enhancement of paper machine productivity and reduction in converting problems.

He named stickies reduction as one of the main tasks, although no direct measurable relationship existed between such problems on the one hand and the stickies area in the finished stock on the other.

The new stock preparation design on PM 4/7 was prepared by analysis of the existing 4/7 plant, evaluation of experience from plant 5 and selective trials in the R & D facility at Voith Sulzer in Ravensburg. Criteria for the finished tissue stock are high, on the one hand as a result of the exacting runnability requirement of the tissue machines and converting plant, but above all due to the required end product properties such as

brightness, dirt specks, strength and bulk. The stock preparation must be sufficiently effective to produce a finished stock product with tightly defined, high quality standards from waste paper raw materials with a very wide range of properties. The improvements included more efficient screening in the medium consistency range. Here, the screen basket holes were reduced from 1.6 mm to 1.2 mm and an additional slot screening stage with a slot width of 0.2 mm installed. Furthermore, the slot widths of the screen baskets in the low consistency fine screening were reduced from 0.25 mm to 0.15 mm.

A VarioSplit of the latest design ensures an increased removal of fillers and fines and hence a further improvement of product quality. Further expectations included even better paper quality, advantages in the converting sector and reduced cleaning requirements on the paper machine itself.

The upgraded plant 4/7 was restarted in March '97. The author was able to report a successful start-up. Initial results confirmed that this investment has lived up to the high expectations placed on it. For instance, the reduction in stickies area improved from 88% to 97%.

# NEWS FROM

## Stock Preparation Division: Screening – a tool for stickies removal



**Screening is an important process step in stock preparation, particularly with regard to stickies removal. This article illustrates the main aspects of screening, starting with an examination of fundamentals.**

**Afterwards, the Voith Sulzer modular screen concept is described, which covers a wide variety of applications. Finally, ways are discussed of solving as many screening problems as possible by well-thought out integration of screens in the system concept.**

*The authors:  
P. Schweiss,  
R. Rienecker,  
Product Group  
Screening,  
P. Respondek,  
Dr. S. Schabel,  
R&D, Stock  
Preparation*

### Fundamentals

The size of particles screened is a direct function of screen hole or slot size. In the case of stickies, however, not only their size is important but also their geometry (stickies particles are predominantly flat rather than spherical) and their deformability. These three parameters of stickies size, geometry and deformability must be carefully analyzed for effects on screening. To improve screening, increasingly finer screen slots are used in order to remove the smallest possible particles. Since stickies and fibres are more flat than spherical, their orientation in the flow path through the screen is an important factor.

As shown by the test results in *Fig. 1*, different slot widths and screen basket surfaces can give the same screening efficiency. Slot width and screen basket surface profile affect screening efficiency and the maximum possible specific flow through the screen in any particular case. They also influence operating reliability. All these parameters have to be taken into account when selecting the optimum screen basket.

Most stickies are deformable. They are more difficult to handle than non-deformable particles, because they can be forced through the basket slots and even desintegrated. Upstream machines and the screen itself must therefore be designed and operated to minimize stickies deformation or desintegration. This means that the shear forces and pressures acting on particles in the machines must be kept as low as possible.

*Fig. 2* shows the effect of consistency on shear forces in a screen. The zone where shear forces are likely to break down toner and stickies particles is shaded in red. For a typical medium consistency screening configuration, this means greater deformation and breakdown of stickies at consistencies higher than about 2.5%, with a corresponding deterioration of screening efficiency.

The pressures in a screen are due above all to the rotor. With a new method for 3-dimensional measurement of local slot velocities at a high spacial and temporal resolution, we can now gather detailed

# M THE DIVISIONS

Fig. 1:  
Influence of slot width and screen basket surface profile.

Fig. 2:  
Shear stress in screens.

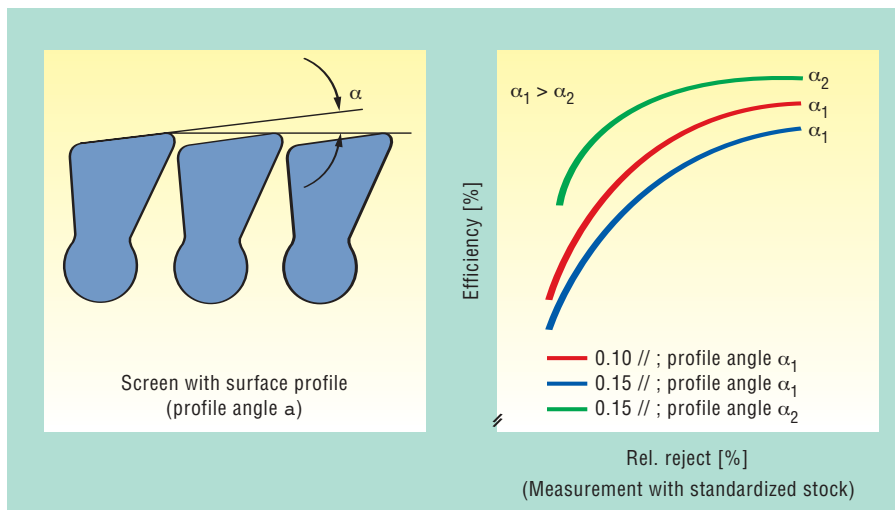

information on local pressures during screening. Typical results using this method are shown in Figs. 3 and 4, where mean slot velocities are plotted per single revolution for a foil rotor and a step rotor. In the latter case, throughput velocities for the same volumetric flow are significantly higher than with the foil rotor.

### Machines

These basic considerations and the operating limits must therefore be taken into account in the design and manufacture of screens. “Classical” waste paper stock screening can be divided into the following subsystems, each of which must have a tail screening stage tailored to the specific requirements:

- Prescreening in the medium consistency range with hole and slot screens
- Fine screening in the low consistency range with fine slots
- Approach flow screening, where high paper machine runnability is the main requirement. Here, both hole and slot screening are used, but the trend is clearly towards fine slot screening.

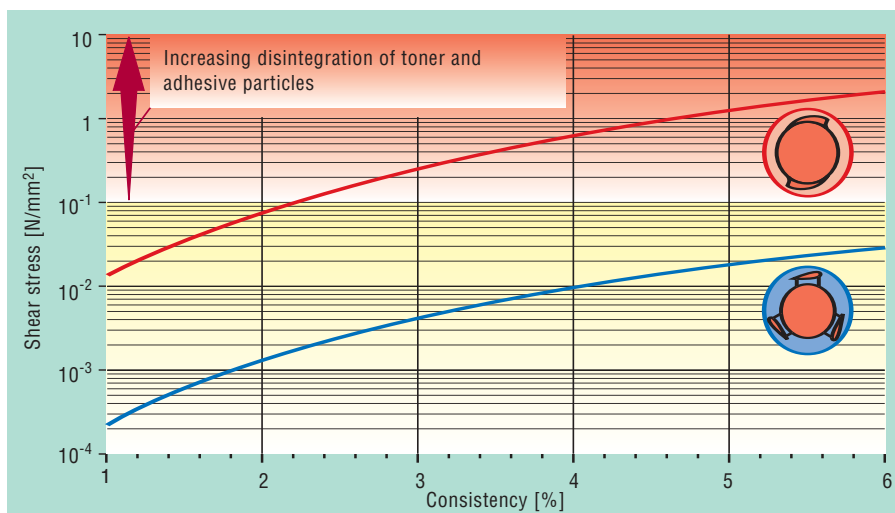

Fig. 3:  
Dimensionless slot velocity with foil rotor.

Fig. 4:  
Dimensionless slot velocity with step rotor.

Product quality is chiefly determined by fine screening using fine slots. Such fine screens can only be operated with stock which has been suitably deflocked, since this is the only way to ensure that individual fibres can pass through the fine slots. This fluidization process can be carried out either by screening in the low consistency range, or by medium consistency screening which requires a high energy input.

As mentioned previously, however, high energy input with high resultant turbulence and shear stress has a negative effect on stickies removal.

### Rotors

We carried out extensive tests on various different rotors under the same operating conditions to find out their effects on throughput (Fig. 5) as well as on energy consumption and screening efficiency (Fig. 6). Removal of stickies and contaminants is shown in Fig. 6 for a bump rotor and a foil rotor. Contaminants removal by the bump rotor was impressive, almost as high as the flow-optimized foil rotor. The results for stickies clearly show that their removal is governed by other laws than those applying to relatively rigid particles. By contrast with the foil rotor, stickies removal with the bump rotor is far less efficient than contaminants removal. This is due to the high tip speed required for the bump rotor in the medium consistency range. Here again, this clearly confirms

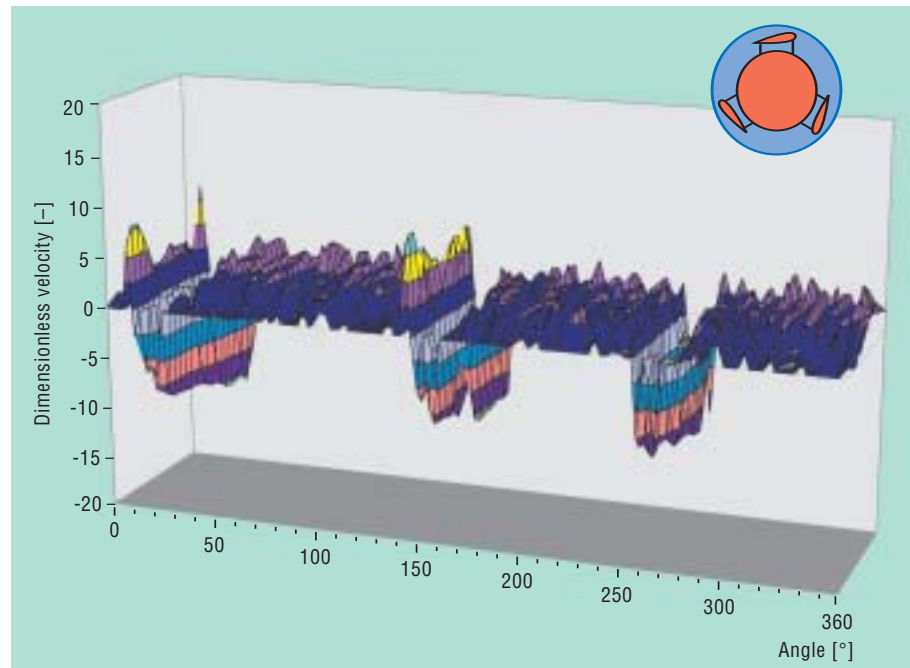

3

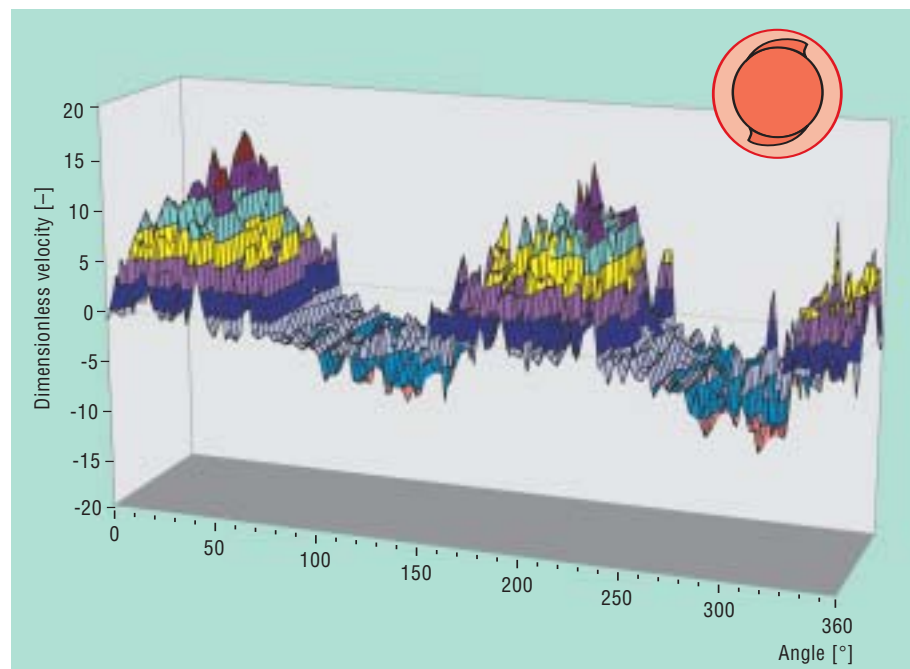

4

Fig. 5: Throughput limits of various rotors as a function of peripheral speed.

Fig. 6: Influence of turbulence on various characteristics of disturbing components.

Fig. 7: Rotor types.

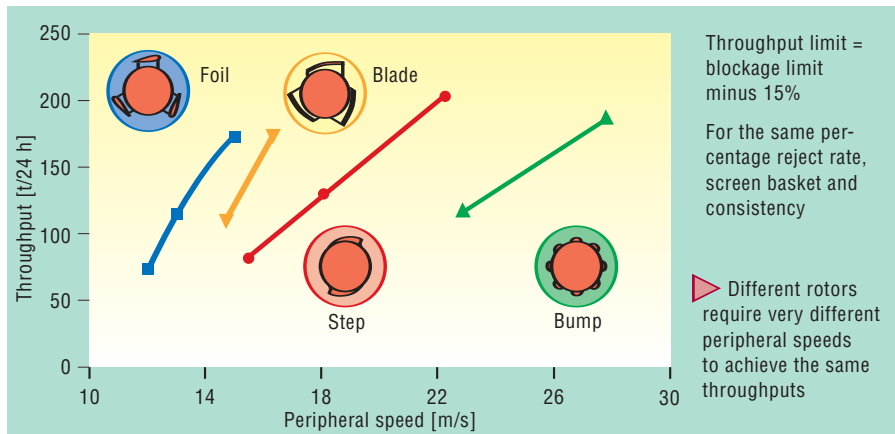

that deformable particles such as stickies cannot be efficiently screened out in the medium consistency range (>2.5%), even with the finest slots, as shown in Fig. 2.

Screens not only have to remove stickies. This fact is illustrated by the wide application range of Voith Sulzer rotors shown in Fig. 7:

- Lobed rotor (medium consistency screening):  
A rotor for coarse screening, primarily hole prescreening.
- Bump rotor (medium consistency screening): Mainly used for medium consistency slot screening, this gives relatively high efficiencies but requires high tip speeds.
- Step rotor (medium consistency screening):  
Suitable for both hole and slot screening, this also helps relieve and protect the downstream stages.

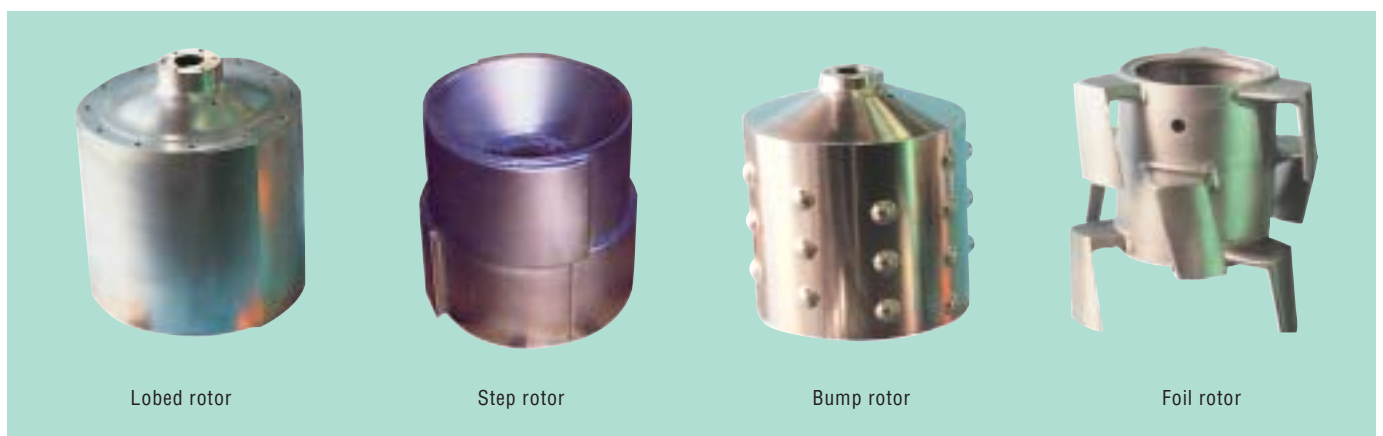
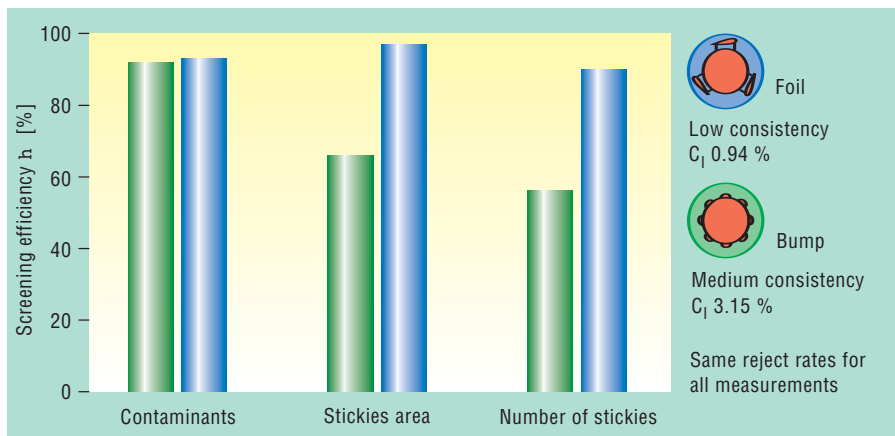

5

6

7

Fig. 8:  
Influence of slot width on thickening factor (fractionation effect).

Fig. 9:  
Influence of different surface profiles on operating performance and screening efficiency.

Fig. 10:  
MultiSorter housing  
Left: Conical housing.  
Right: "Fish mouth" accept outlet.

■ Foil rotor (low consistency screening):  
Used for fine screening and in the approach flow, this allows extremely gentle screening with very low energy consumption.

**Screen baskets**

Fibre losses and fractionating effects depend very much on screen basket slot width and surface profiles. Measurements taken on a deinking plant show that with decreasing slot width, the thickening factor increases disproportionately (Fig. 8).

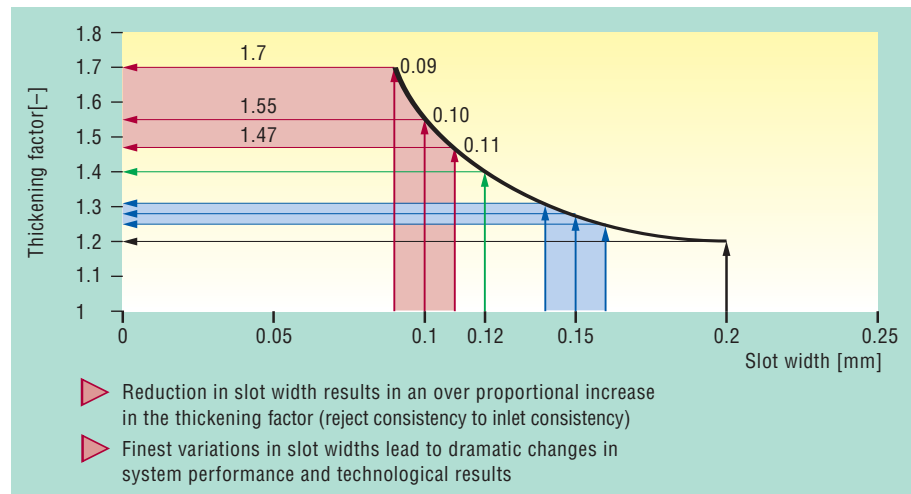

Even the smallest changes in slot width for the same volumetric flow rate have a dramatic effect on reject quantities. These changes in slot width can be within the order of magnitude of tolerances for the profile bars (> 0.01 mm).

The finer the slot, the more important the surface profile for efficient screening, and the greater the sensitivity to wear, as the example in Fig. 9 demonstrates.

This shows the surface structure of the same screen basket in the new condition, and after several months of continuous operation on a stock with a high sand content. While the surface becomes worn, the slot width remains unaltered.

As a result, the thickening factor rises under otherwise completely identical conditions, and the stickies removal increases dramatically.

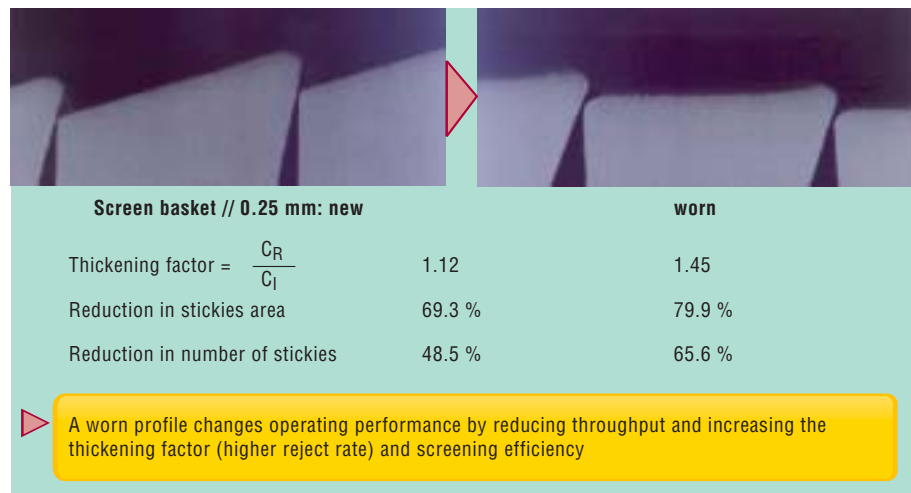

**Housing**

Another important screen component is the housing, the effect of which is usually underestimated.

As shown by our flow measurements on screen baskets, the usually cylindrical geometry of most conventional housings results in widely varying flow velocities

through the screen basket. Hence, "mean hole or slot velocity" is a purely theoretical parameter which has little or nothing to do with practice. In actual fact, local velocities can be up to ten times the mean velocity, depending on inlet and outlet geometry. Even reverse flow from the accepts side can occur at other points. It goes without saying that such conditions



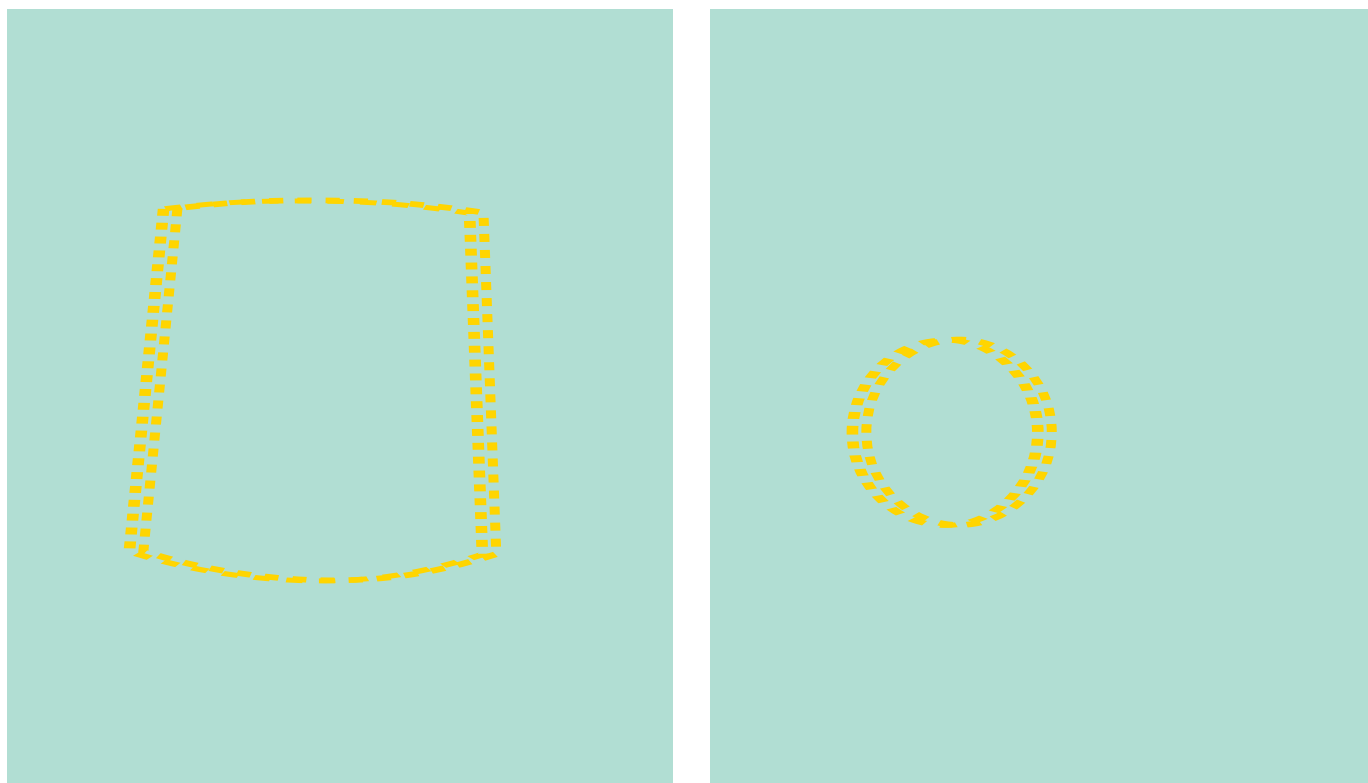

10

are not conducive to optimum screening efficiency.

Using extensive computer simulations based on the latest test results, Voith Sulzer has therefore developed a new style screen housing which significantly contributes to evening out the flow patterns through the screen basket. In future, this new housing will be used for all our screens, both in the low and medium consistency ranges. It forms the basic module of our new MultiSorter family and is already well-proven in the approach flow as the MultiScreen MSA. The design ensures virtually even flow velocities throughout the accepts zone. This very demanding construction from the fabrication point of view serves as a model for the new generation of pressure screens.

*Fig. 10* shows the main features of the new conical housing, which widens toward the base so that the greatest housing volume is at the level of the accepts outlet. This has a “fish mouth” shape with a very large cross-section where it joins the housing,

thus also helping to even out the flow. As a result, “gentle” rotors can be used or correspondingly high throughputs are possible.

As already mentioned, the MultiSorter housing is part of our new modular screen concept – the “Multi” family. If we consider the various medium and low consistency screening applications: approach flow, fractionation, mechanical and chemical pulp screening as well as tail screening, and additionally the wide range of sizes and speed alternatives, more than 150 different versions are available – without taking into account all the various screen baskets. With this carefully designed modular system, a wide range of possibilities can be realized without excessive outlay or negative effects on technological performance.

### Systems

The design of screening systems, both subsystems and complete systems, has to take account of numerous technological and plant-related conditions. Due to the

widely varying requirements of raw materials and finished stocks, a custom-tailored solution is required in every case.

Thorough system analysis is necessary on one hand for optimum screening efficiency, and on the other hand to ensure operational reliability, particularly with the finest slot sizes. *Fig. 11* shows fibre characteristics from the overflow of a first screening stage at 0.1 mm slot width in a deinking plant for wood-containing DIP stock. On the same scale, a C-bar screen basket section with 0.1 mm slot width is also shown. Clearly, the large fibre bundles can hardly pass through these fine slots, thus resulting in a substantial fractionation effect. These large fibre bundles originate mainly from the TMP component of newsprint, but similar fibre sizes are also found in brown stock.

Consequently, the system layout and the minimum possible slot width have to be selected not only with regard to dirt removal, but also taking account of fibre characteristics.

Fig. 11:  
Size comparison of wood-containing DIP and C-bar profile.

Fig. 12:  
Overview of screening systems in deinking plants.

Screen baskets with 0.1 mm slot width can nevertheless be used with woodfree DIP stocks, however, as shown for example in a large European DIP plant where a 0.1mm slotted Voith Sulzer screen is in successful service.

If such fine slots are not possible because of the fibre characteristics, optimum efficiencies can only be achieved by appropriate system layouts, in principle by using several screening stages in series.

We have investigated numerous combinations and analyzed the resultant data with computer simulations, particularly with regard to stickies and fine slots, since efficiency is a function of the kind of particle as well as machine layout.

Principally, high efficiency can only be assured through greater outlay. A cascade or A-B type layout costs more than a simple forward-flow system, for example, but it ensures higher overall screening efficiency. And together with the subsystem layout and integration into the system as a whole, this is a very important factor in operational reliability.

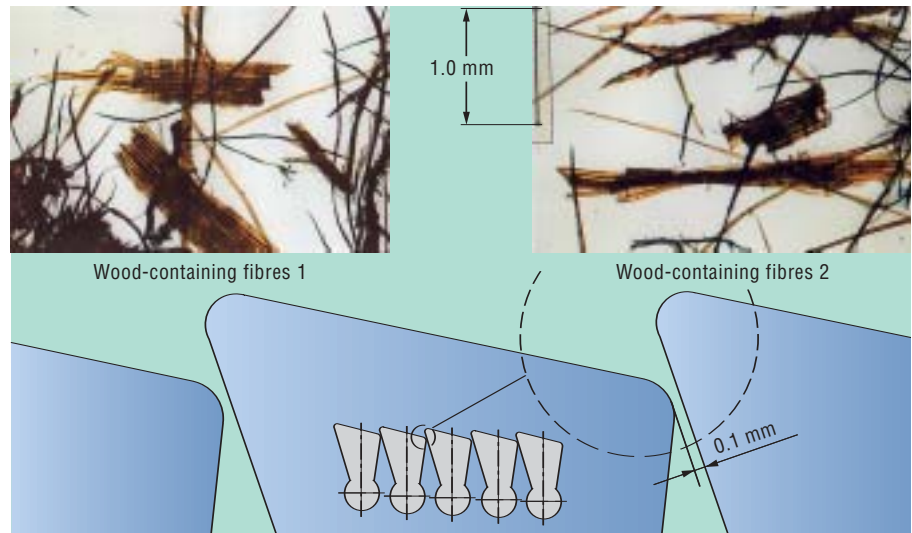

11

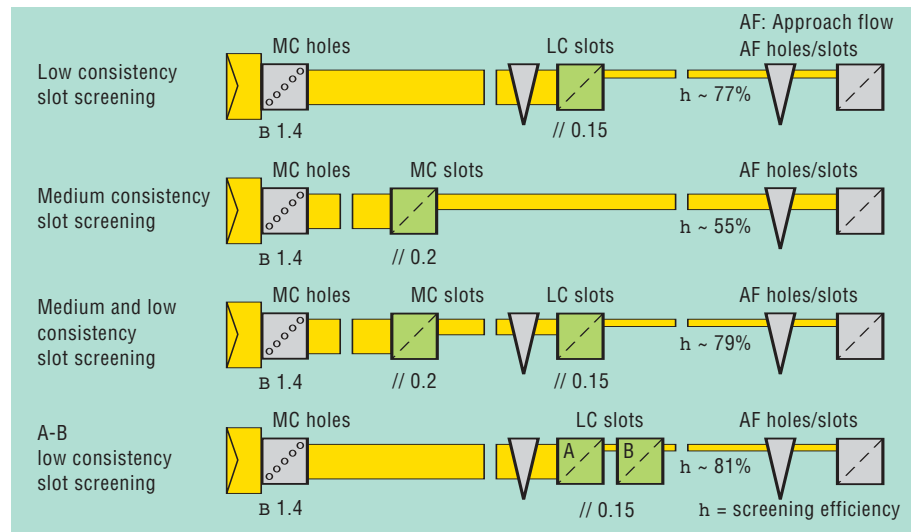

12

Fig. 12 shows an overview of typical screening systems today for deinking stock. All deinking plants include medium consistency hole screening for efficient removal of coarse contaminants as a pre-condition for effective slot screening. The actual stickies screening stage, however,

comprises 0.15 mm slot screening or even finer in special cases.

Our preference for stickies screening is low consistency slot screening, because by using gentle foil rotors at low consis-

tency, maximum screening efficiencies can be attained for all kinds of stickies.

Furthermore, the sensitive screen baskets can be protected against wear by an upstream low consistency cleaner stage.

Fig. 13:  
Screening efficiency as a function of screening area for the various screening systems.

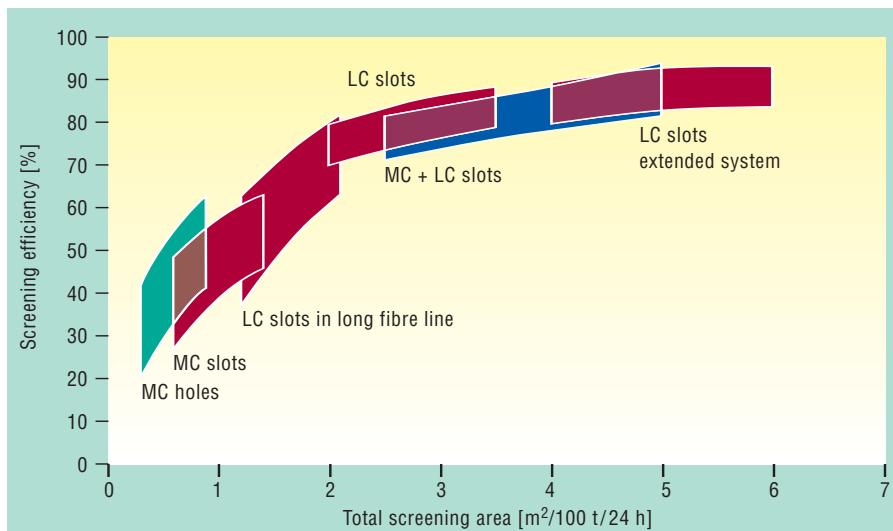

icates that high stock quality can only be ensured by high system outlay.

This means that various compromises are usually made because of the widely diversified requirements on the finished stock. This applies just as much to DIP as to brown grades, but as a basic principle, quality can be improved by connecting medium and low consistency screening systems in series. Another way of improving quality is to connect low consistency slot screens in series – in fact, this kind of so-called A-B system is not only simpler to install but enhances screening conditions as a whole. It costs the most in terms of machine investment, but screening efficiency is the best: the higher the outlay, the higher the efficiency. Very simple systems such as slot screening in the approach flow only, or medium consistency slot screening, are only appropriate for lower quality stocks. And greater attention has to be paid to operating conditions, particularly when slot screening is only used in the approach flow.

## Conclusions

With the flexible screen modules now available, it is possible to remove contaminants and stickies from stock very efficiently and cost-effectively, with reliable operation. Optimum results can only be attained, however, if a wide variety of facts and findings are taken into account in the design and operation of the screening systems.

For stickies screening in brown stock systems, basically the same relationships apply as in deinking plants. An additional point must be taken into account, however: after hole prescreening, the stock contains much higher stickies concentrations than in deinking plants, together with various abrasive contaminants such as sand and glass, and it also has a high flake content. Depending on the raw material, there might also be a considerable proportion of long, stiff fibres, which are highly susceptible to fractionation in slot screening.

The same kind of fine slotted screen baskets used for low consistency screening are also used in our medium consistency machines. As regards the complete stickies spectrum, however, screening efficiencies are not so high here – but passing the accepts through subsequent

low consistency slot screening attains surprisingly high efficiencies. This shows that although MC slot screening needs less investment outlay, it is not appropriate for high quality finished stock.

Likewise for brown stock preparation systems, we recommend low consistency slot screening for maximum stickies removal, preceded by a cleaner stage to reduce screen basket wear. As we have seen so far, the numerous system alternatives differ significantly with regard to investment outlay and attainable efficiency. Fig. 13 summarizes the efficiency ranges of various system configurations as a function of total screening area. The latter is a relatively direct measure of system investment outlay. Despite substantial differences in their details, all the screening systems in this diagram lie on an asymptotic curve. This clearly indi-

## Paper Machinery Divisions: “Pole position” for Voith Sulzer shoe presses

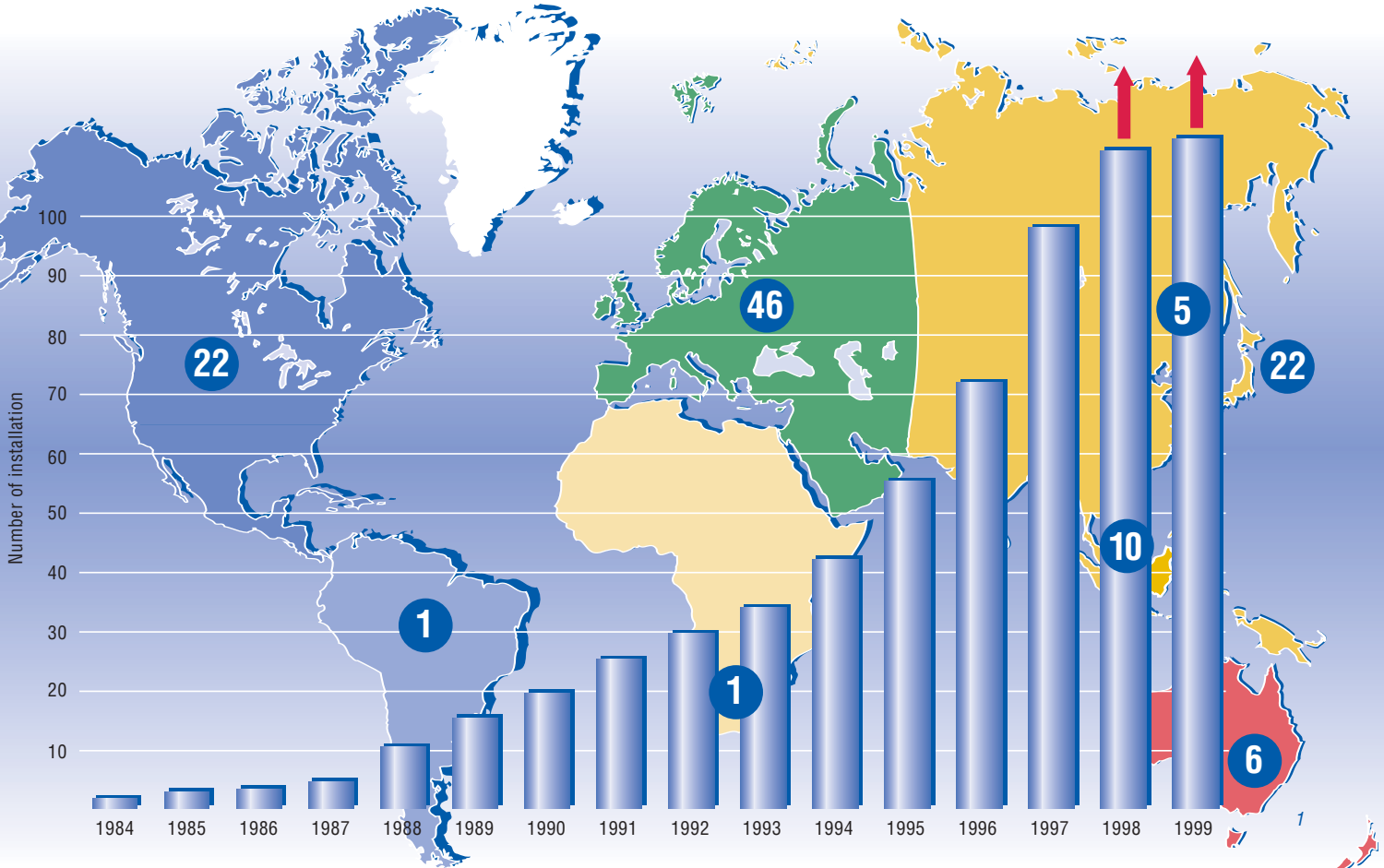

### Market

In the first decade after launching the enclosed shoe press in 1984, a total of 42 Voith and Sulzer Escher Wyss shoe presses went into service (see Fig. 1). The Voith Sulzer Paper Technology merger in 1994 brought a symbiosis of these two very successful systems – the best features of the Flexonip press and the Nipco-

Intensa-S press were integrated into the new NipcoFlex press. Thanks to the sum total of Voith and Sulzer know-how and the elimination of counterproductive patent restrictions, the resultant product offered papermakers substantial benefits.

So far more than 85 customers in 28 countries have recognized the technological advantages and cost effectiveness of the NipcoFlex press (see Fig. 1). In the first 30 “twogether” months alone, orders were booked for 60 shoe presses, and at the time of writing, 83 Voith Sulzer shoe presses are in service worldwide. With 300 years of collective experience and more than 100 units sold, Voith Sulzer is

indisputably market leader in modern shoe press technology.

### Technology

The NipcoFlex shoe press is outstanding for its uncomplicated and absolutely dependable technology. The shoe is lubricated entirely hydrodynamically and ensures an optimal line force profile (see Fig. 2). This is characterized by a steep pressure rise prior to dewatering, followed by a very gentle increase during the dewatering process to a relatively low maximum pressure. The pressure drop in the nip outlet is steep again to prevent rewetting. This shoe press comprises a



The author:  
Wolfgang Schuwerk,  
NipcoFlex Technology

Figs. 1:  
Voith Sulzer shoe press sales growth and regional representation.

Fig. 2:  
NipcoFlex press nip.

Fig. 3:  
Effect of pressure pockets on line force profile.

Fig. 4:  
Cross-section through a NipcoFlex press.

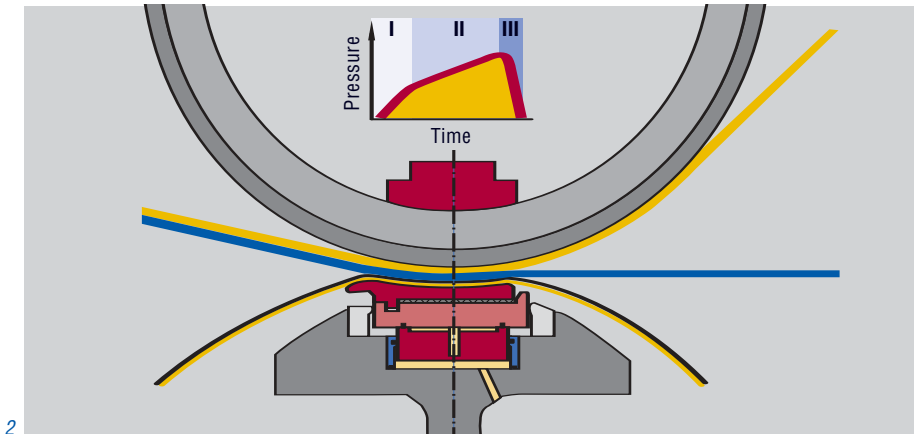

2

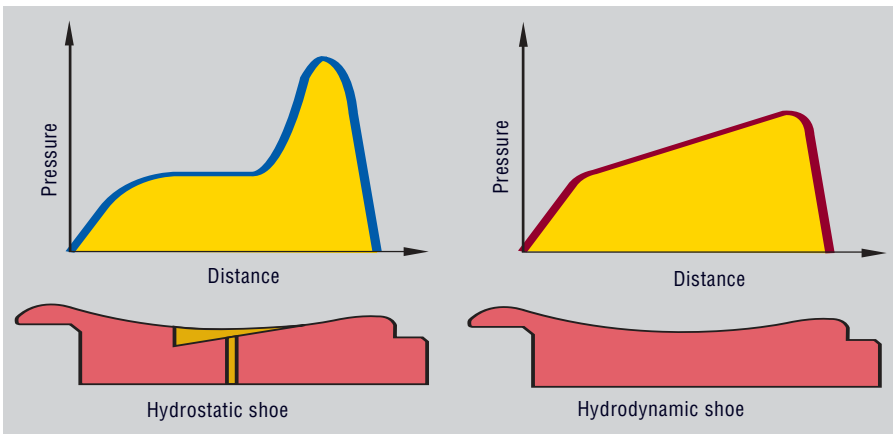

3

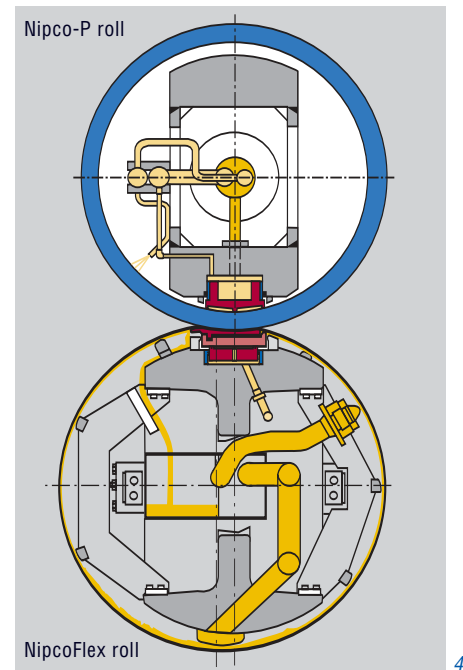

4

concave upper part and a rigid lower part, separated by an insulation layer – a patented compound construction which largely prevents thermal deformation of the shoe due to cold zones in the nip intake and hot zones in the outlet. These are unavoidable in a lubrication nip because of oil heating. In other designs, cold hydrostatic oil is fed directly to the nip via pockets in order to limit the temperature differential between inlet and outlet. Apart from the energy consump-

tion involved (= pressure x flow rate), oil feed pockets have two serious drawbacks. They generate pressure plateaus (Fig. 3) which at constant line force unavoidably cause steeper pressure gradients due to the equal areas under the pressure curves, at the same time leading to higher maximum pressures. Operating experience with pocket-type oil feed shoe presses has also shown that the press roll sleeve can easily be damaged from within when wads pass through the nip.

NipcoFlex shoe presses are pressed against the mating roll by a single row of hydrostatic elements (Fig. 4). This elegantly simple pressing mechanism is possible because thanks to the patented asymmetrical arrangement of the roll sleeve, the shoe is displaced toward the nip inlet relative to the pressing direction. A symmetrical shoe arrangement would either generate an undesirably symmetrical line force profile, or require the extra outlay of a double row of pressing elements to ensure an optimal profile as in Fig. 5.

The NipcoFlex loading elements are arranged quasi as a single zone over the roll width, and supplied with oil pressure

Fig. 5:  
Longitudinal section through a NipcoFlex press.

Fig. 6:  
Voith Sulzer QualiFlex press sleeve.

by a common lead (Fig. 5). Smaller elements are only fitted at the roll ends to take account of any variations in web width. Within the approx. 150 mm wide end zones, the line force and moisture profile can thus be varied considerably. Thanks to the flexibility of the shoe, the shoe press in any case applies an ideally equalized line force over the nip width, without any additional error. The result is an absolutely uniform CD moisture profile. Here again, experience in practice has shown that no zonal correction is necessary with NipcoFlex presses. With unequal line force distribution – for example to compensate in advance for CD moisture profile alterations in the dryer section – felt characteristics change unequally during service life and thus cause additional production problems.

Another advantage of the NipcoFlex shoe press is the positionally stable Nipco-P maiting roll (Fig. 5). Since the roll shell is directly supported in the bearing distance, its position is unaffected by the unavoidable beam deflection and thus ensures constant conditions for the press sleeve advance and doctors. Since the hydrostatic loading elements of the Nipco-P roll have the same area as those of the shoe press, control is very simple and reliable, with no risk of damage to the roll shell or bearings. Furthermore, the direct force transmission between rolls via patented links allows an extremely compact design.

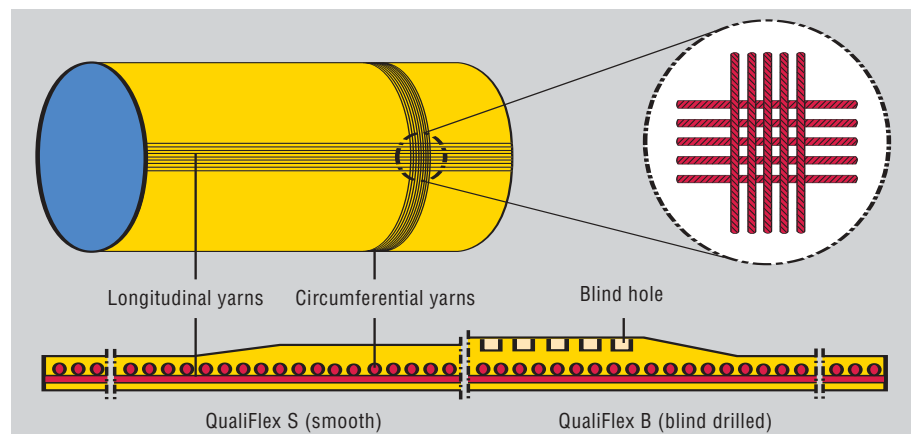
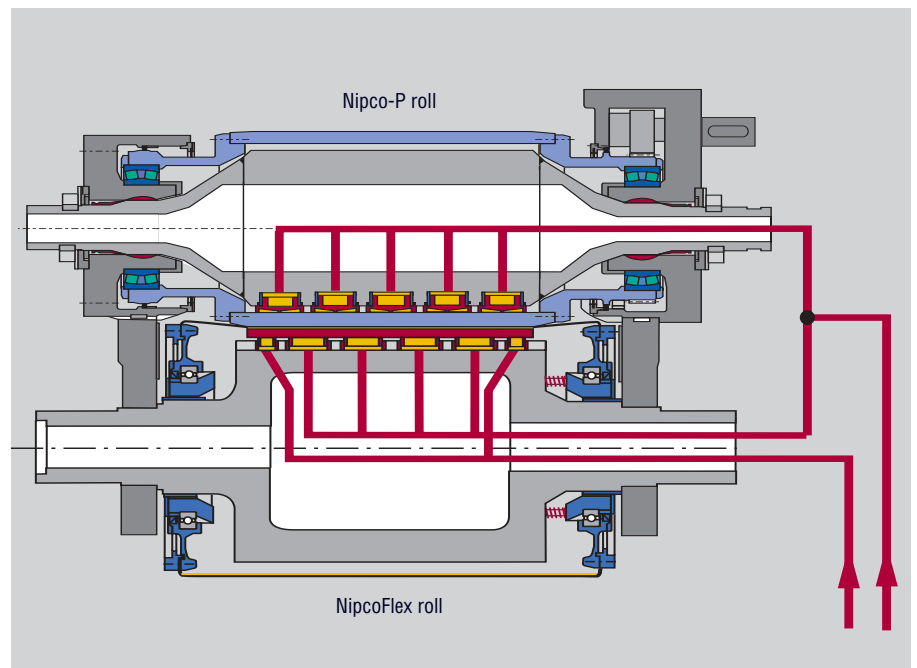

The NipcoFlex press and associated QualiFlex press roll sleeves comprise a very cost-effective solution – thanks to outstanding press sleeve life, for example. Blind-drilled QualiFlex sleeves with endless nonwoven reinforcement yarns fully

embedded in polyurethane (Fig. 6) are breaking world records in service life, measured both in terms of nip passes and operating days. In the 3rd nip of a paper machine for copy papers, for example, a QualiFlex sleeve running at 1180 m/min

Fig. 7:  
QualiFlex Top Ten running times.

Fig. 8:  
Change of strength properties after installing a  
NipcoFlex press in a testliner machine.

Fig. 9:  
Tandem NipcoFlex press on a 7250 mm wide  
paper machine for linerboard.

Rank	Installation	Country	Speed (m/min)	Sleeve Life (Days)	Nips (Millions)
1	Neusiedler	A	1190	303	95
2	VP 4-Melbourne	AUS	580	370	75
3	Perlen	CH	1140	175	70
4	Hoya	GER	500	516	68
5	VP 6-Sydney	AUS	800	239	64
6	Cardella	I	520	354	62
7	VP 6-Sydney	AUS	780	235	62
8	Neusiedler	A	1090	231	62
9	Braviken	S	1500	161	60
10	Zülpich	GER	900	263	58

reached 95 million nip passes – corresponding to 303 days of operation. Another QualiFlex sleeve ran for 516 days in a linerboard machine. And as shown by the top ten list in Fig. 7, these extremely long operating times are no exception by any means.

The dependability of the NipcoFlex/QualiFlex system protects operators today against unplanned roll sleeve changes, and enable this type of shoe press to be used at the highest possible operating speeds.

**Applications**

The first shoe presses were used in board and packaging paper machines. They covered practically the whole operating range both of narrow and wide machines as well as slow and fast machines. Operating results with NipcoFlex shoe presses in the last nip of packaging paper machines show increases in dry contents up to 15% or even above in some cases. Final dry contents of 51 to 54% are possible on linerboard machines. This kind of dry content increase naturally brings considerably higher density, so that burst pressure, tensile strength, RCT and plybond strength are likewise improved significantly (Fig. 8). Suitable concepts for kraftliner, testliner and corrugated board are Tandem-NipcoFlex presses (Fig. 9), which apart from the aforementioned increase in dry content also bring the advantage of closed and extremely reli-

7

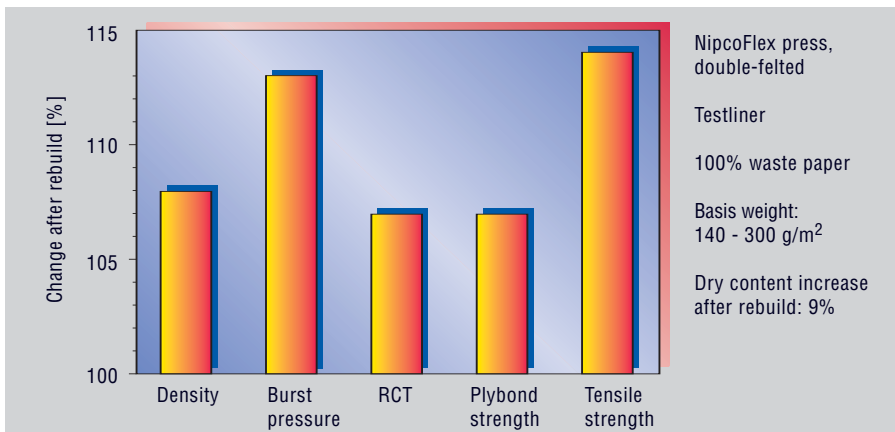

8

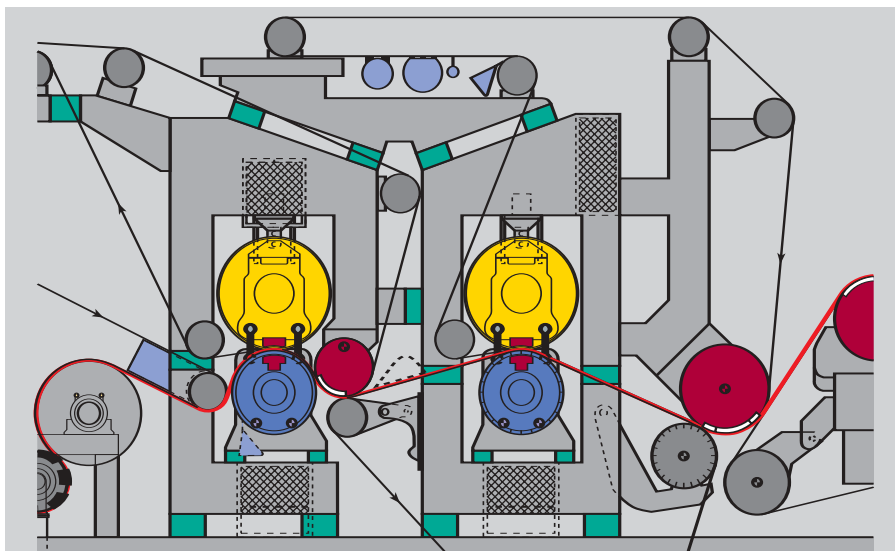

9

Fig. 10:  
Press section results on Perlen PM5 before and after rebuild.

Fig. 11:  
Press section of a paper machine for wood-free copy paper.

able web run, from the wire section through both presses to the dryer section.

For packaging paper machines, shoe presses are state of the art. Their flat pressure gradients, long dewatering times and low line forces also make them ideal for board and sack kraft. It is precisely with these grades, which are particularly sensitive to compression, that gentle dewatering brings higher quality and greater economy. The latest application for NipcoFlex presses is in pulp dewatering machines.

NipcoFlex shoe presses have long proved their technological advantages and cost-effectiveness for writing and printing papers as well. Our one hundredth shoe press – a NipcoFlex – will be installed in a recently ordered newsprint machine. There are two main reasons why these shoe presses can be installed in fast machines: replacement of granite rolls by ceramic rolls and the high quality of flexible press sleeves with long operating life. Excellent references in writing and printing paper machines bear witness to the eminent suitability of NipcoFlex shoe presses in this field.

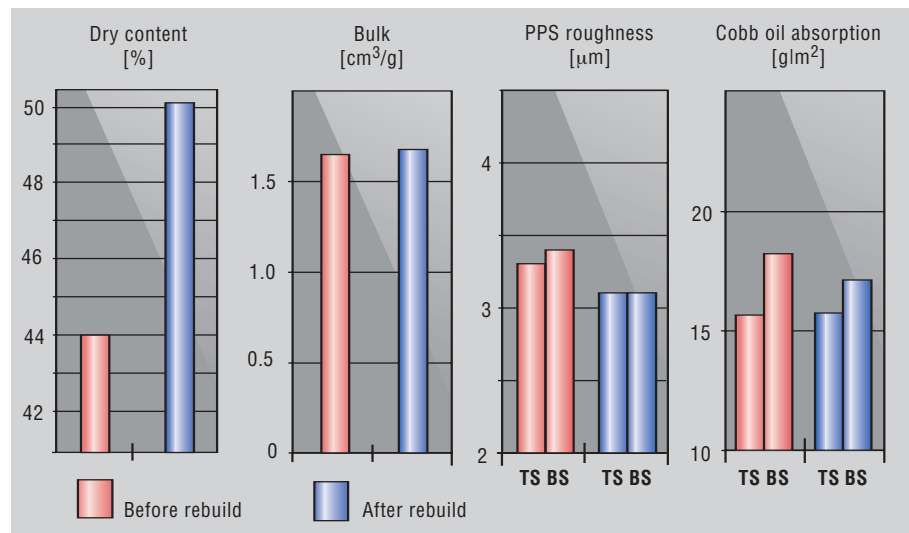

10

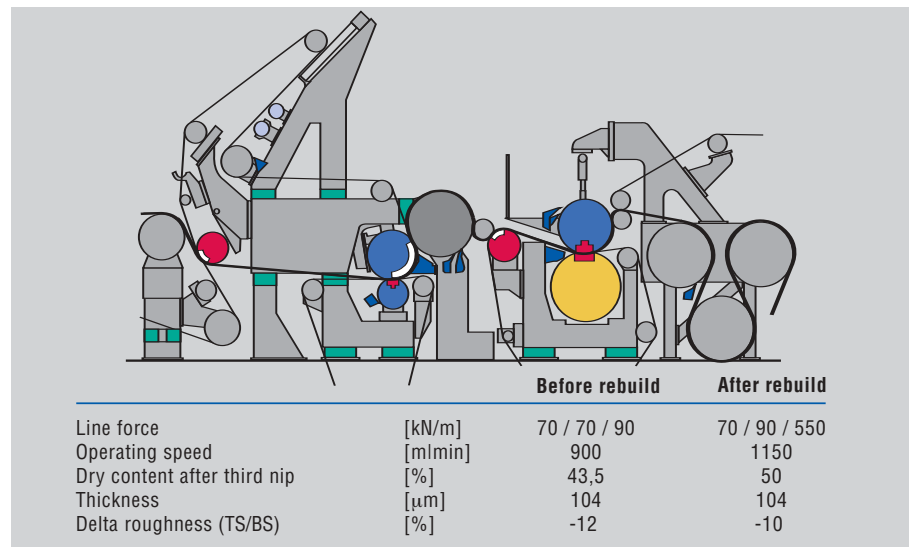

11

■ The world's first shoe press in a newsprint machine has been operating since 1994 with great success. Expectations have been exceeded not only by the 27% production boost, but also by quality enhancements with regard to

volume, smoothness, oil absorption and 2-sidedness (Fig. 10).

■ The second shoe press for writing and printing paper has been operating in a machine for wood-free copy paper since 1995. A dry content increase

from 43.5 to 50% and outstanding sleeve service life have proved its cost-effectiveness (Fig. 11).

■ The third Voith Sulzer shoe press in the writing and printing paper segment represents a real quantum leap: de-



Fig. 12:  
DuoCentri NipcoFlex press on a 9650 mm wide newsprint machine.

Fig. 13:  
Effect of shoe press on characteristics of wood-free coated paper.

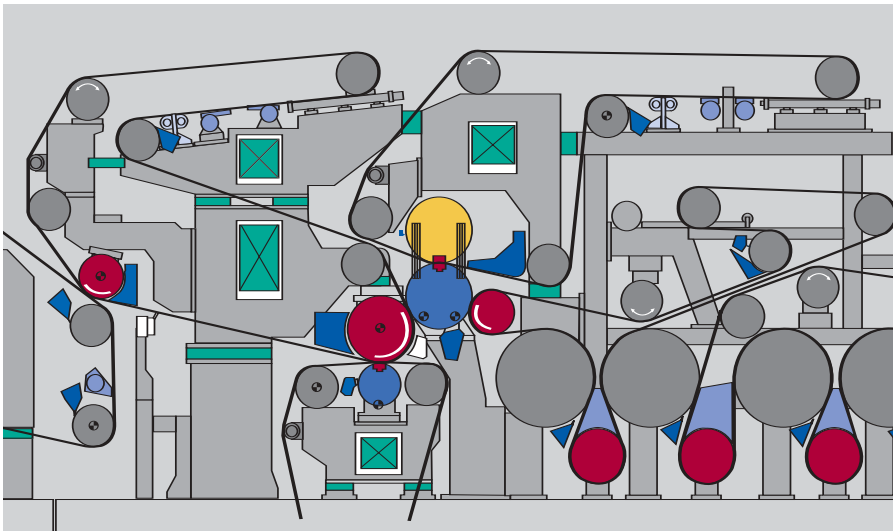

sured by the NipcoFlex press, the dry content of these mark-sensitive grades can easily be increased by 3-4% (Fig. 13). One of the most impressive aspects here is that the NipcoFlex press is basically very simple and reliable despite its high technological level. The problems only too familiar with conventional presses – such as irregular moisture profiles or felt barring due to vibration feedback – just do not occur with this design.

Totally eight shoe presses now operating in writing/printing paper machines, another twelve are currently on order.

12

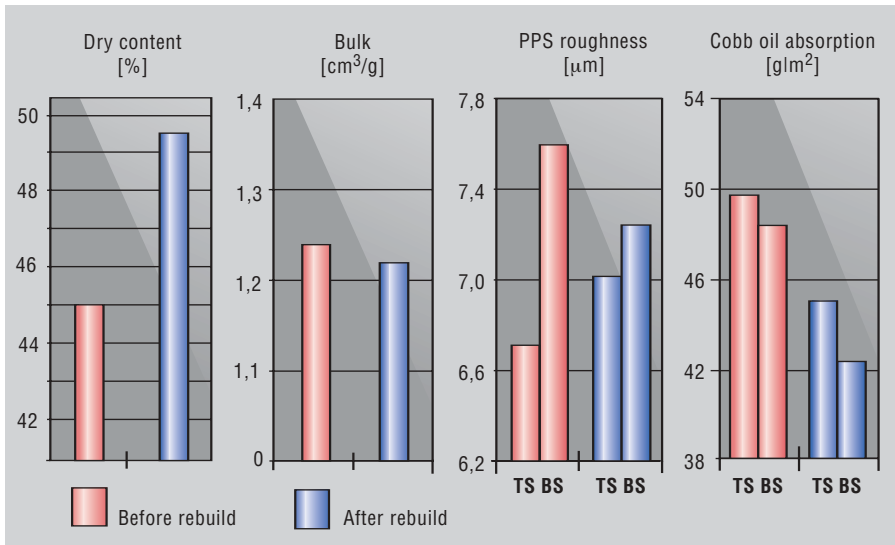

13

signed for a speed of 1800 m/min, this press holds the world speed record at 1672 m/min. And with a wire width of 9650 mm, the production is 270,000 t/y. The DuoCentri NipcoFlex press with shoe in the third nip (Fig. 12) enables

closed web run with high dry content in the first open draw, thus ensuring excellent runnability.

■ Equally good references are available in the wood-free coated paper sector. Given an optimal line force profile as en-

### Cost-effectiveness

Apart from the technological advantages of the NipcoFlex shoe press, one of its greatest benefits is cost-effectiveness. The higher dry content enabled by this press allows considerably greater output. Even a 2% runnability increase, for example, increases annual production from 250,000 to 255,000 tonnes. So assuming an overheads contribution of 600 DM/t for newsprint, the overall contribution increases by 3 million DM per year. And with production increases around 20% or more, the cost-effectiveness of the NipcoFlex shoe press becomes indisputable – promising a really fast return on investment.

The cost-effectiveness of this press is not only due to increases in output, however: NipcoFlex shoe presses also reduce specific production costs.

Fig. 14:  
Production cost savings by a DuoCentri NipcoFlex press compared with a conventional 4-nip press.

Fig. 15:  
DuoCentri NipcoFlex press (left).  
Duo NipcoFlex press (right).

This is well illustrated by comparing a DuoCentri NipcoFlex press with a conventional 3-nip press followed by straight-through press. At only 3.5% higher dry content, the DuoCentri NipcoFlex press in a newsprint machine operating at 1500 m/min saves DM 5.20/t in steam costs, and DM 0.80/t in electrical power due to elimination of the fourth press. Furthermore, with a total of only three felts, it saves DM 0.90/t in clothing costs. Likewise roll cover and trimming costs are reduced by DM 0.70/t (Fig. 14). Including the cost of new press sleeves, the DuoCentri NipcoFlex press brings overall savings here of about 6.20 DM/t. This result is further improved by lower investment costs in the press section, and in some cases lower investment costs due to a shorter dry section.

#### Future outlook

Although today's shoe presses meet current demands very well, new concepts are under development for further improvement of technological results – in particular for printing and writing papers.

Future requirements are already clear: closed web run, highest possible dry content, good structural and surface characteristics with the least possible 2-sidedness. At the same time, the design must be compact and reasonable priced. An innovative solution in this direction is the Duo-NipcoFlex press – a 3-nip press with shoe presses in the first and third nip

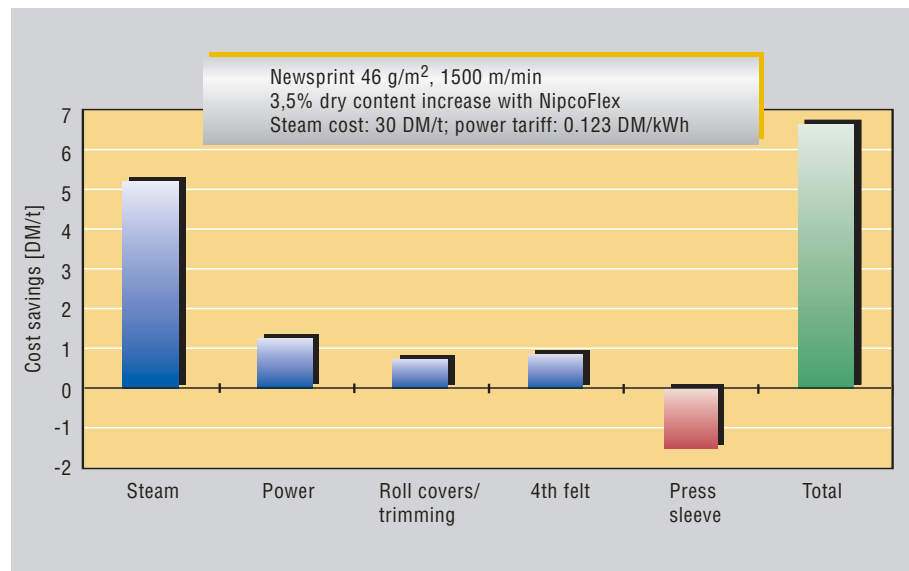

14

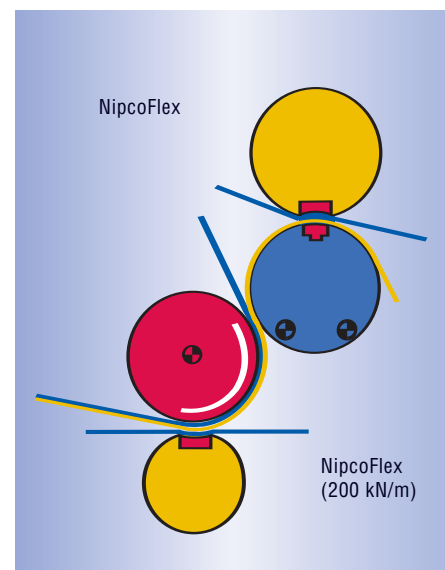
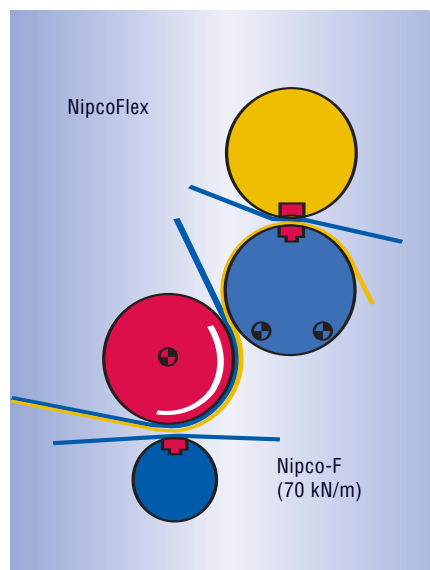

15

(Fig. 15). This concept enables extremely gentle dewatering from beginning to end, thus improving paper quality still further. The maximum line force of such a shoe press in the first nip against a suction roll

is limited, but the dewatering rate is high here in any case. Apart from higher dry content due to the higher line force in the other nips, above all characteristics such as curl and cockling are improved.

## Paper Machinery Divisions: Web and tail transfer systems in board and packaging paper machines

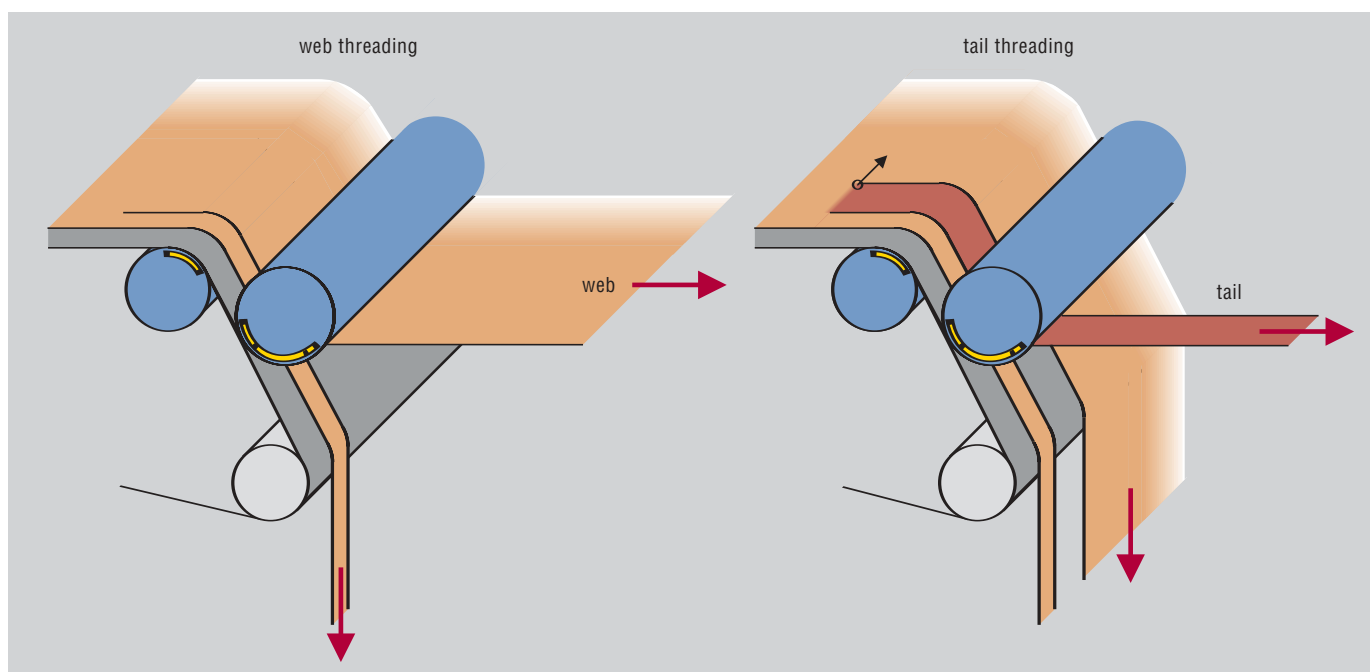

The author:  
Peter Haider,  
Paper Machinery  
Division Board  
and Packaging

**Sheet transfer is an increasingly important factor in advanced board and packaging paper machines. Many paper and board producers currently tend to optimize existing machines and improve their runability rather than to order new machines.**

A significant step towards enhancing the runability of a paper or board machine is the installation of a system safely transferring the sheet from one section to the other. Such a transfer system is not only an economic solution but it also adds to the safety of the machine crew.

Sheet transfer is becoming an increasingly complicated process. Faster and faster machine speeds with a continual reduction of basis weights and the increased use of waste paper make the use of closed transfer systems without open draws necessary. This article gives a short overview of the most important transfer positions in state-of-the-art board and packaging paper machines and it presents the trans-

fer systems and methods used in the different positions.

### Fundamentals

The two basic transfer methods are: web transfer, tail transfer.

Tail transfer is used if the web itself is too heavy to get it through to the next position. For this, an approx. 20 cm wide tail is cut from the web and moved to the next position. Then, the tail is widened out to full width.

### Strength development as a function of dryness

Every transfer operation is determined to a large extent by the strength of the web

Fig. 1:  
Web transfer versus tail transfer.

Fig. 2:  
Relative sheet strength in a paper or board machine.

Fig. 3:  
Combi Tandem NipcoFlex press.

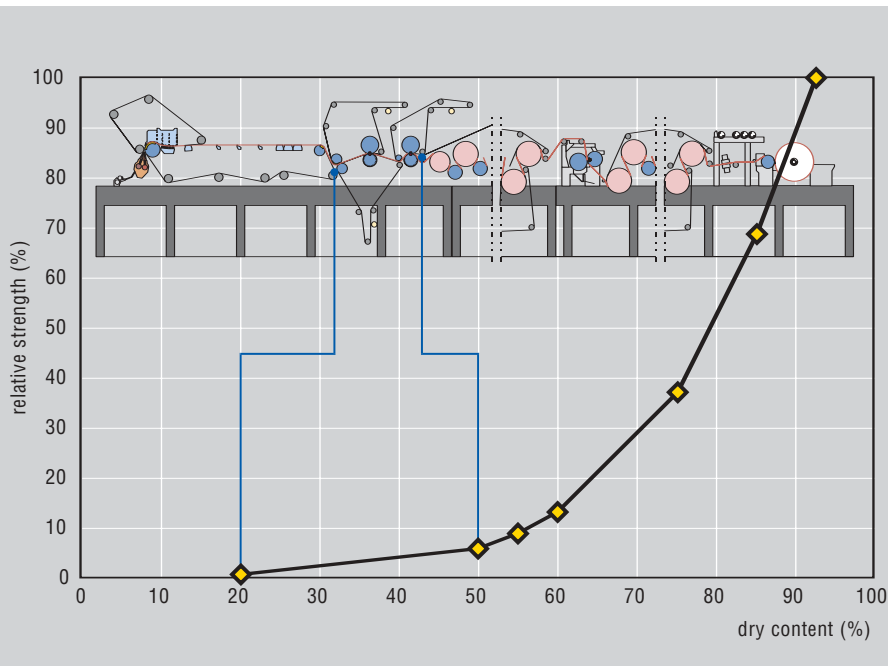

2

or tail. Fig. 2 shows the relative strength of the web/tail from the beginning to the end of the production process.

After the wire section, the dry content is approx. 20%, which corresponds to a relative strength of less than 1%. In other words, paper strength in this position is less than 1% of the final strength of the web. As the dry content increases, the strength of the paper web increases as well. In spite of that, relative strength after the press section is not more than 4%. Due to these low strengths, transfer in these positions has to satisfy particularly high requirements.

Another critical point in every paper machine is where the paper is threaded through the Speedsizer or size press. Since the web absorbs moisture and therefore loses strength as it passes through the size press, there is an increased risk of web breaks.

### Transfer systems at the wet end of a linerboard machine

#### Transfer from wire to press section

At basis weights of up to 300 g/m<sup>2</sup>, safe transfer is ensured by closed transfer systems utilizing a pickup roll for transferring the web from the wire section into the press section. Higher basis weights may cause sagging of the web or web edges. The web transfer approach used on Tandem NipcoFlex presses without a bottom felt in the last press Fig. 3 offers a closed

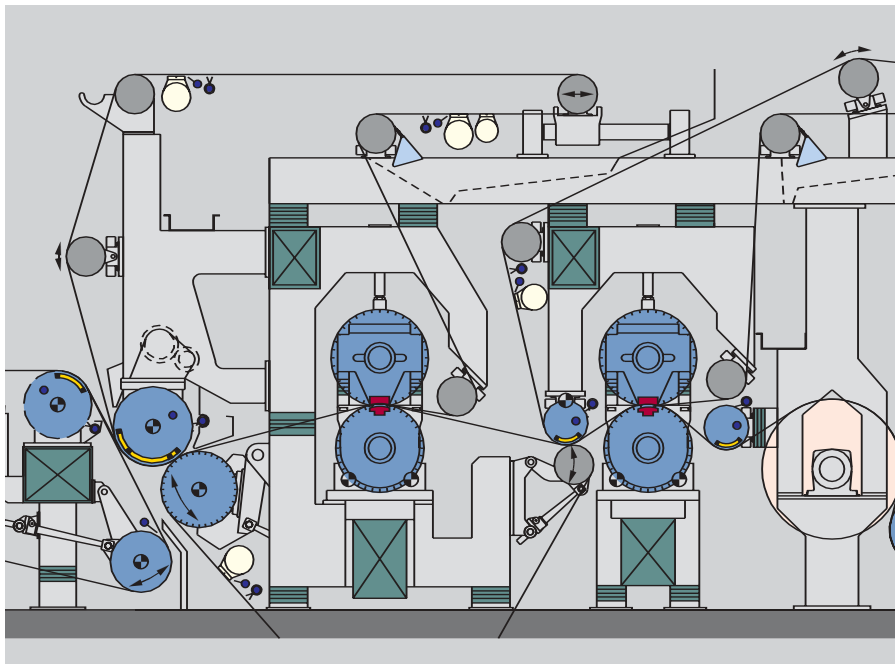

3

Fig. 4:  
Tail transfer from press section to pre-dryer section.

Fig. 5:  
Transfer systems at board machine wet end.

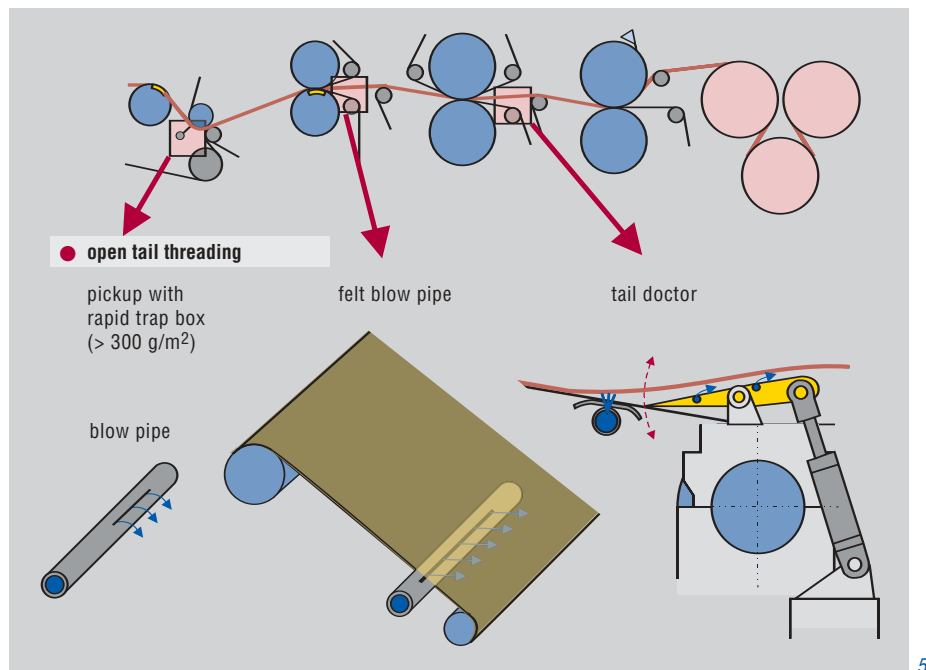
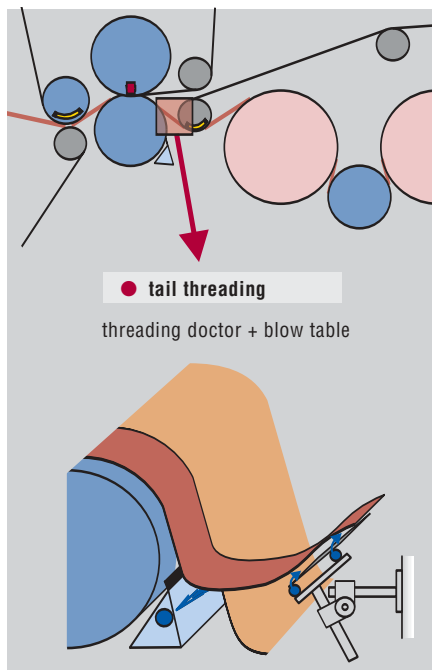

web run through the press section. The web is picked up at its full width by the pickup roll and carried through the press section without open draws.

Transfer sequence:

- full width goes into broke pit
- cutting of 1st edge trim by means of edge spraying device
- transfer of web without 1st edge trim with pickup roll onto pickup felt
- closed web run through press section
- full width goes into press pulper after last press
- loading of presses
- cutting of 2nd edge trim (size adjustment) and transfer tail by means of travelling squirt

■ transfer of web into pre-dryer section.

The advantages of this method are:

- constant web width travelling through the press, independent of shrinkage and web width
- permanent position of edge spraying devices
- constant setting of web width at pickup roll (no transfer zone required)
- uniform strain on felts across the width
- constant edge relief setting in the shoe press.

Transfer from press section to pre-dryer section

For tail transfer from the smooth bottom

press roll into the pre-dryer section, a threading doctor and a blow table are used (see Fig.4).

First, the full width runs from the smooth bottom press roll into the press pulper. To transfer the paper, an approx. 20 cm wide tail is cut from the web and blown into the pre-dryer section by means of air nozzles integrated in the threading doctor and the blow table.

**Transfer systems at the wet end of a board machine**

Transfer from wire to press section

For basis weights larger than 300 g/m<sup>2</sup>, open tail transfer is used. A slotted blow-pipe located behind the wire lifts the

Fig. 6:  
AP-Shur.

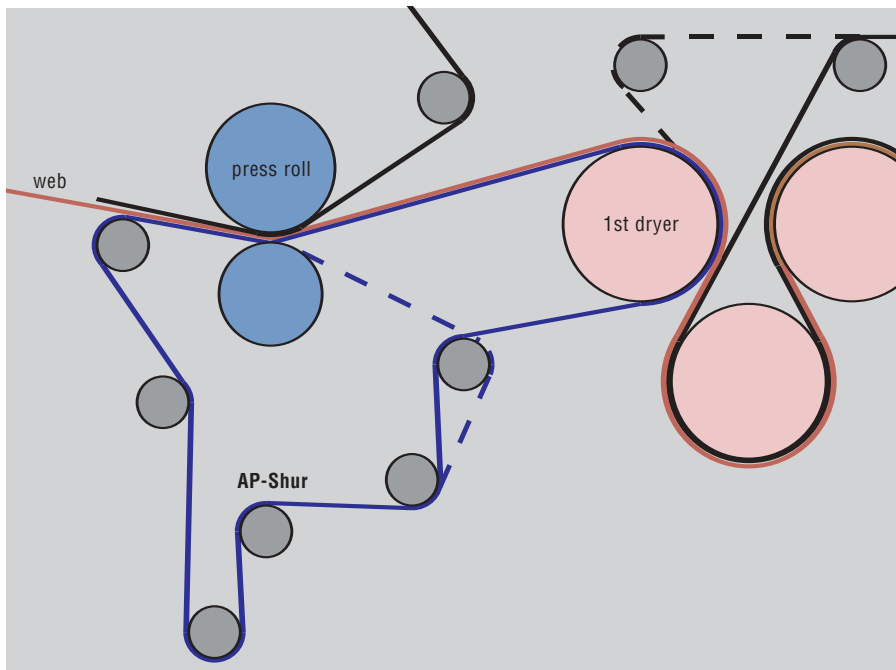

transfer tail from the wire and directs it towards the pickup roll (see Fig. 5). The high-vacuum transfer zone integrated in the pickup roll carries the tail into the press section.

The pickup roll is used as a suction guide roll, which upon web transfer is moved into its operating position. It is not absolutely necessary to force the roll into the wire. With a distance of 2-3 mm the open draw is so short that the stiffness ratio of the board becomes very small. The MD/CD ratio changes with increasing speeds and decreasing basis weights, and in these cases the “real” pickup roll gives better results. It is to be expected that for smaller basis weights the “real” pickup roll will become first choice.

#### Tail transfer between presses

Due to the open press configuration in a board machine the tail has to be taken from the felt after each press and directed to the next position. This can be done manually with blow pipes or automatically with tail doctors.

If it is done manually, the tail is slightly lifted by means of the blowpipe arranged under the felt (see Fig. 5) and directed by other blowpipes to the next position. Transferring the tail manually requires great skills of the machine crew.

With an automatic system, the tail doctor (see Fig. 5) is forced 2-3 mm into the felt, then the tail is taken from the felt and

blown by integrated air nozzles onto the next press felt. When the tail has been transferred, the tail doctor is lifted off the felt.

#### Tail transfer from last press into pre-dryer section

The rope nip can be placed upstream or downstream of the last press. In the first case, the advantage is that the tail can simply be taken by hand and inserted into the rope nip before the last press nip; at the same time, the loose end has to be torn off at the cleaning doctor of the smooth roll.

Placing the rope nip after the last press makes the design less complicated but transfer at high speeds becomes very difficult since a blowpipe has to be used.

#### **Closed web transfer from press section into pre-dryer section using an AP-Shur press felt**

The AP-Shur press felt permits web transfer without open draws from the last press into the pre-dryer section. The press felt is wrapped around the first dryer (see Fig. 6). The heated felt improves the transmission of heat between press felt and paper and increases the dry content of the web. This approach is preferred in double-felt presses. During transfer, the web passes through the last press nip, is slightly lifted by the top felt and only then drops onto the bottom felt. As the paper web is slightly lifted from the bottom felt,

Fig. 7:  
Tail transfer systems in a linerboard machine  
dryer section.

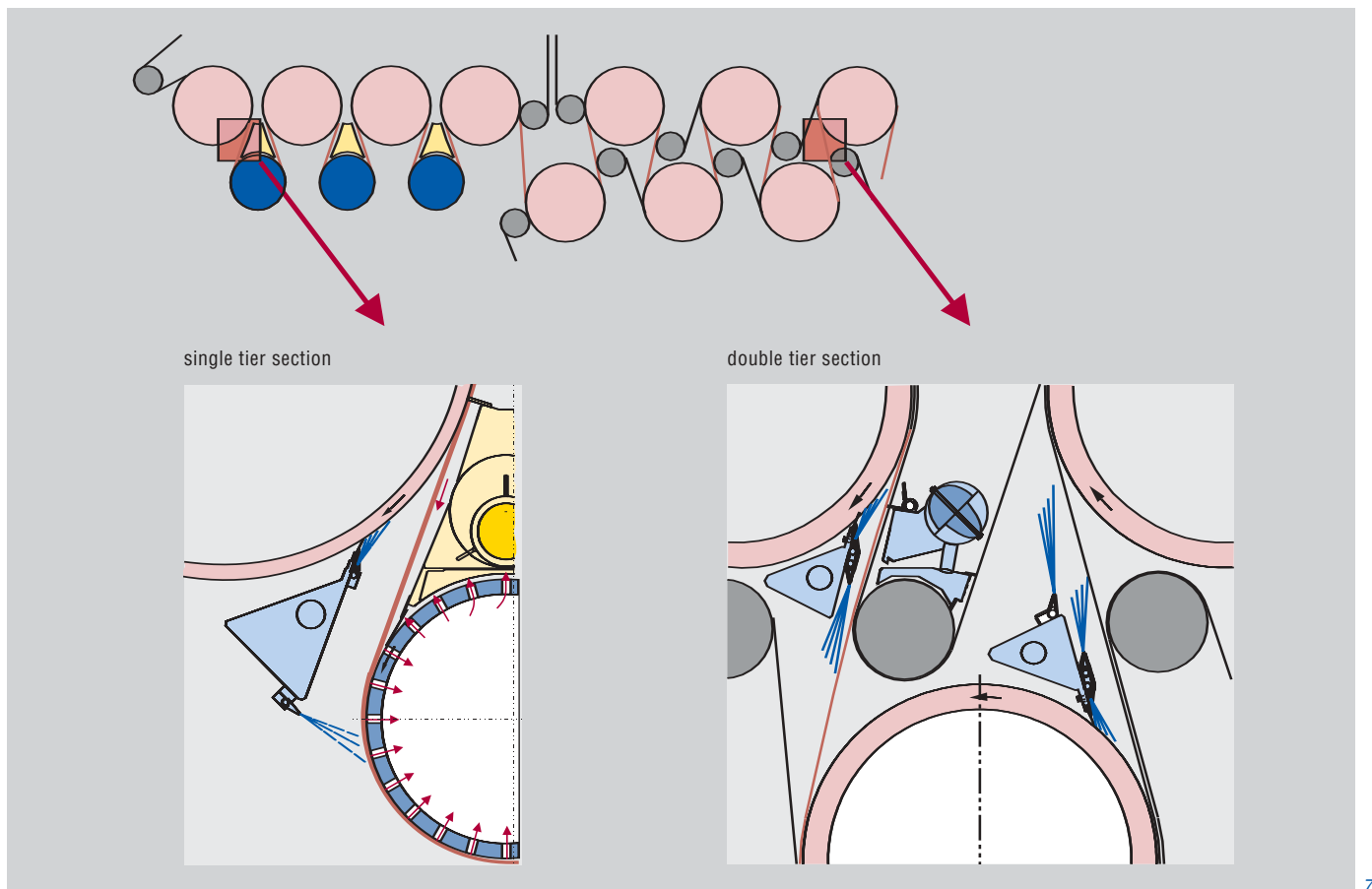

an air cushion forms between the felt and the paper web, which prevents remoistening of the paper.

Benefits:

- no open draws - less web breaks
- less CD shrinkage
- higher strength (burst,  $SCT_{CD}$ )
- higher dry contents
- vertical entry of the web into the pre-dryer section
- suitable for all basis weights

#### Tail transfer in the dryer section of a linerboard machine

Basically, there are two ways to thread the paper tail through the dryer section of a paper machine:

- rope transfer
- ropeless transfer

Since tail transfer utilizing ropes is a well-known method, this article will focus on ropeless tail transfer. In a ropeless tail transfer system, every dryer is provided

with a doctor, which may either be a conventional design or a special transfer doctor with a width of approx. 1 m.

#### Single-tier dryer section

2 blowpipes are mounted on each doctor. The first blowpipe is used for picking the tail up from the dryer. The air jet is directed towards the doctor blade. The second blowpipe, designed as a slotted blowpipe, places the tail onto the vacuum-assisted reversing roll (see Fig. 7). The reversing

Fig. 8:  
Web cutter for ropeless transfer.

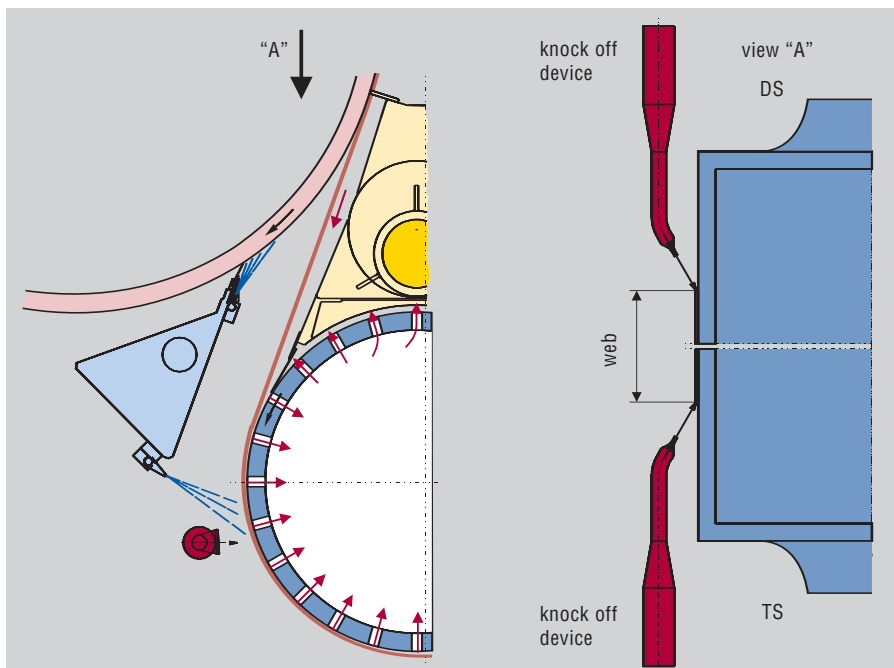

roll has a transfer zone on the tending side to ensure safe tail transfer around the roll. The blowpipes at the individual dryers are actuated in groups. 4 dryers at a time are supplied with air, air supply to the next group of 4 dryers is started with a delay. The air rate of each blowpipe can be set separately. To reduce air consumption the blowpipes are operated in a pulse mode, which means that the air is switched on and off every 0.5 seconds.

#### Double-tier dryer section

In contrast to tail transfer in a single-tier dryer section, in a double-tier configuration the tail is directed into the nip between the bottom dryer and the dryer fabric (see Fig. 7). 3 blowpipes, also

mounted on the doctor, blow the tail into the nip between the top dryer and the top dryer fabric. The asymmetric arrangement of the guide rolls and the use of BS stabilizers aid in the transfer of the tail. The individual blowpipes are supplied with air in the same way as those in a single-tier configuration.

The advantages of ropeless tail transfer are:

- reduced transfer times
- enhanced runability (no changing of ropes or rope pulleys)
- less maintenance (no lubrication of rope pulleys)
- reduced risk of accidents

In practical applications, ropeless tail transfer is the approach adopted for basis weights up to 180 g/m<sup>2</sup> and machine speeds over 470 m/min. Solutions for extending the use of this transfer method are currently under development at Voith Sulzer.

#### Cutting devices in ropeless transfer systems

The two types of cutting devices are the tail cutter and the web cutter:

The tail cutter is a blowpipe installed on the tending side. This blowpipe is set to a certain position relative to the tail and cuts the tail by means of an air jet. The time when the tail is to be transferred is determined manually (pushbutton). The tail cutter is installed at the first vacuum-augmented roll in the dryer section.

A web cutter has knockoff blowpipes mounted both on the tending and on the drive side (see Fig. 8). The blowpipes tear the web from the side and the web tension ensures full separation across the machine width. The web cutter can be activated either manually with a pushbutton or automatically by means of photocells (in the dryer section). The web cutter is located at the last reversing roll of a single-tier dryer section. This configuration prevents the paper from piling up in the double-tier dryer section in the case of a sheet break.



Fig. 9:  
Tail transfer systems in the area of the  
Speedsizer, calender, and pope reel.

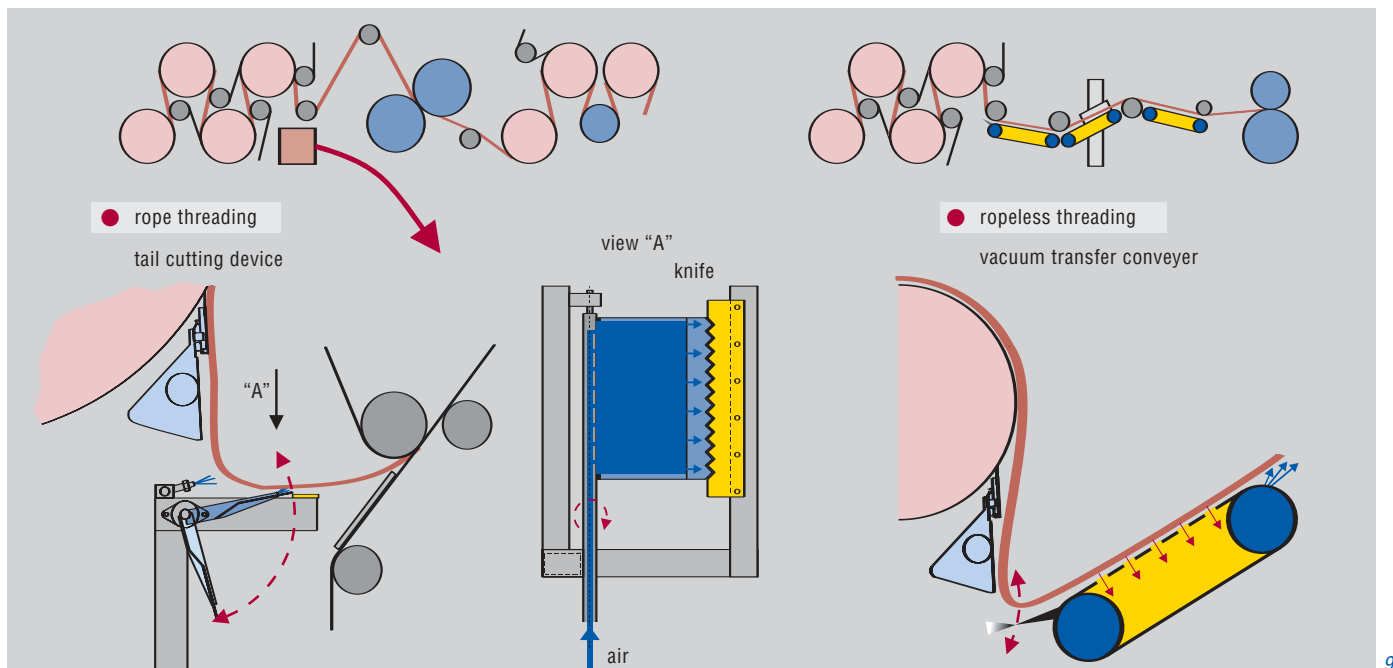

### Tail transfer in the dryer section of a board machine

In the dryer section of a board machine, the tail is transferred with 3 ropes: one inner and one outer supporting rope and a central clamping rope. As in board machines basis weights are high and speeds are low, hardly any problems occur in tail transfer.

### Tail transfer systems in the area of the size press, calender, and pope reel

In these areas, ingoing dryness and, consequently, relative paper strength is high, which is a great benefit in the transfer process. Fig. 9 shows two ways

how to transfer the tail and it shows where the units are installed. Also here, there is the ropeless approach using vacuum transfer belts on the one hand and the cutting devices using rope systems on the other.

#### Tail cutter with rope transfer

A pneumatic cylinder swivels a knife towards a stationary knife. The stationary knife is screwed to a frame. The knife edges have to be set so that a small clearance is left between them. The tail is cut by the two knives and blown by air into the downstream rope nip (see Fig.9). However, at high speeds (1000 m/min = 16.6 m paper/second) the paper will pile up at the knives, so that an uncontrollable

mass of paper is blown into the rope nip, which will repeatedly interrupt production. To solve this problem, Voith Sulzer has developed a new cutter design, the EasyCut. The design and operation of the EasyCut are described in the last chapter of this article.

#### Ropeless transfer

For ropeless tail transfer in the area of the pope reel and the calender, the vacuum transfer belts mentioned before can be used.

This transfer device consists of a tail cutter, a vacuum-augmented transport belt, a blower, and a separate drive for the transport belt (see Fig. 9).

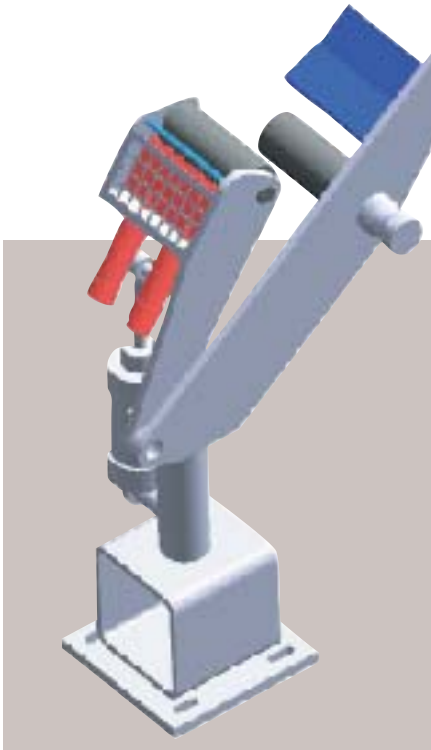

10

The transfer tail is picked up by the doctor from the dryer, cut by the cutting device and placed onto the approx. 15 cm wide transport belt. The transport belt is vacuum-supported. As the belt moves faster than the paper machine, there is no sagging of the tail. Air nozzles are installed at the belt end, which induce sufficient energy in the tail to move it to the next position. In complicated transfer configurations, it is possible to arrange several belts one after the other or use a pivoted design.

#### EasyCut – a new tail cutting and transfer device

The EasyCut, a recent development made by Voith Sulzer Paper Technology, ensures simple, automatic cutting and transfer of the paper tail. Based on a collection of the drawbacks of conventional

cutting and transfer systems observed in practical applications a completely new device was developed. One of the key issues was to solve the problem of paper pile-up and tail cutting at the cutting device. Another focus was on the safe transfer of the tail into the rope nip at any basis weight.

The EasyCut *Fig. 10* works along the following lines: The web is picked up by means of the doctor from the dryer and runs vertically into the pulper *Fig. 11*. The approximately 20 cm wide transfer tail runs down between the clamping and the guide rollers. During transfer, the movable part of the EasyCut is pivoted towards the tail. The roller mounted on the movable part (guide roller) directs the tail towards the clamping roller and maintains tension in the tail. The knife now moves out of its waiting position and cuts

*Fig. 10:*  
EasyCut.

*Fig. 11:*  
Installation position EasyCut.

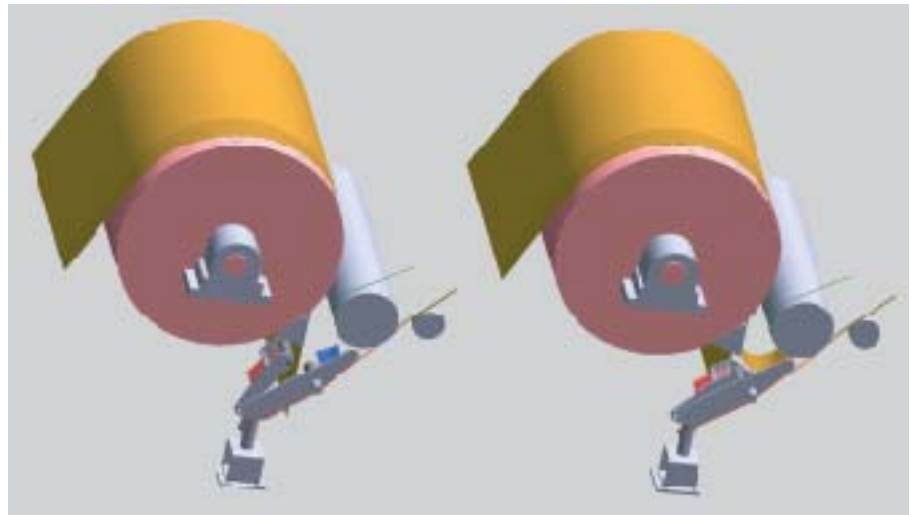

11

the tail. At the same time, the integrated blowpipes are charged with air and immediately blow the tail into the rope nip. As the speed of the roller is slightly higher than that of the paper and the knife is positioned in an optimal manner, no paper will pile up in this area. Upon completion of transfer, the movable part automatically returns into its initial position.

The EasyCut offers the following advantages over conventional tail cutters:

- guiding of paper tail to the cutting point – no pilling-up of paper
- roller speed larger than paper speed for maintaining tension in paper tail
- can be used for any basis weight
- flexible adjustment – space-saving design
- reduced risk of accidents due to retracted knife.



## Finishing Division: Janus – a new technology for old calenders?

The modular Janus concept was developed right from the beginning for using newly designed elements in existing supercalenders and soft calenders (see Figs. 1 and 2).

Of course not every paper grade benefits from the Janus concept – although applications range from improved newsprint through coated and uncoated rotogravure printing paper to various wood-free grades (see Tab. 1).

A cost/benefit analysis of Janus calendering technology soon shows that the highest quality paper grades naturally benefit the most.



*The author: Franz Kayser, Marketing Manager, Project Development, R&D, Finishing Division*

As shown in Table 2, not only the classical surface parameters such as gloss and smoothness are improved, but also optical parameters. Particularly black calendering problems with rotogravure printing papers – which had to be accepted as non-improvable in supercalenders so far – are now a thing of the past. Apart from quality enhancement, however, calendering speed and efficiency can also be improved by this

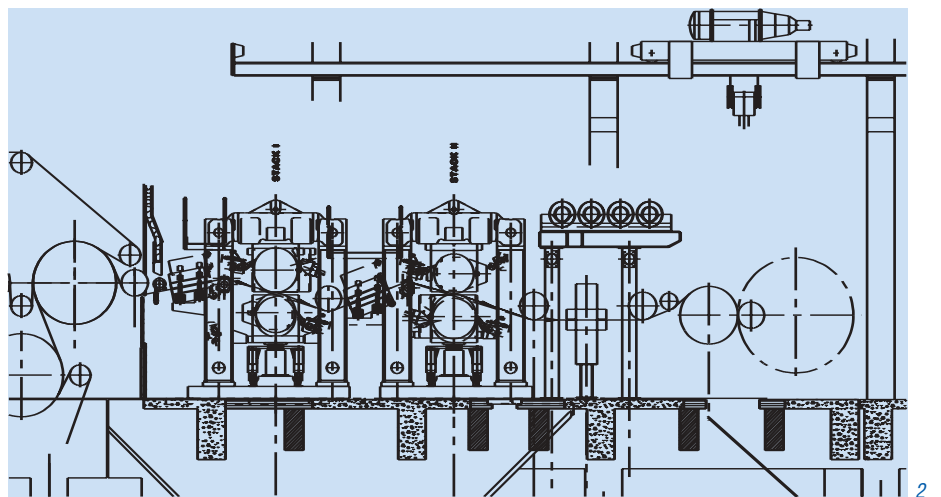
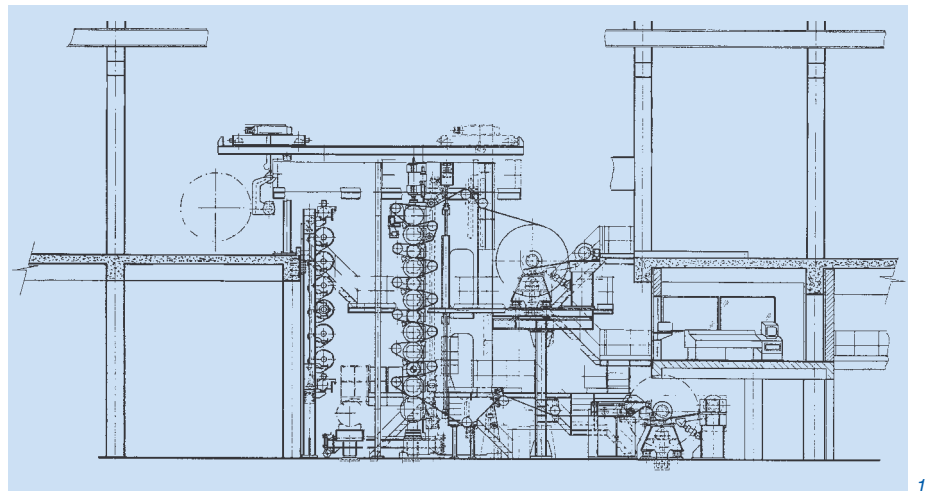

new technology.

Fig. 3 indicates the various possibilities in this direction. First of all, the speed increase allowed by upgrading two existing supercalenders to Janus makes it unnecessary to install a third one. And when paper machine and coating machine speeds are increased, an extra calender is not required for catching up

with the faster output. Thirdly, offline calendering can now be integrated into the papermaking and coating line.

In this latter connection, Fig. 4 shows how a soft calender with its limited technology was replaced with a 6-roll Janus calender – without discarding expensive

Fig. 1:  
Existing supercalender for double-coated papers.

Fig. 2:  
Existing soft calender.

Fig. 3:  
Rebuild possibilities: supercalender  $\Rightarrow$  Janus.

Fig. 4:  
Soft calender rebuild to online Janus calender.

Table 1: Paper grades suitable for a rebuild from supercalender / soft calender to Janus

- SC-C (improved newsprint)
- SC-B (upgraded newsprint)
- SC offset
- SC-A (natural rotogravure)
- SC-A (natural rotogravure +)
- LWC offset
- LWC rotogravure
- 2-sided coated wood-free
- 1-sided coated wood-free

Table 2: Technological grounds for a rebuild from supercalender / soft calender to Janus

**Higher calendering speed with same or better printability and compressibility, through:**

- higher gloss
- higher smoothness
- less brightness loss
- less opacity loss
- less volume loss
- far less “black calendering”
- few missing dots in rotogravure printing
- greater surface strength for offset printing

main components. This kind of upgrade represents considerable progress toward optimal supercalender quality.

One of the basic modules of the Janus concept is the plastic-coated roll used in this technology. For multiple-roll supercalender rebuilds to Janus, Marun

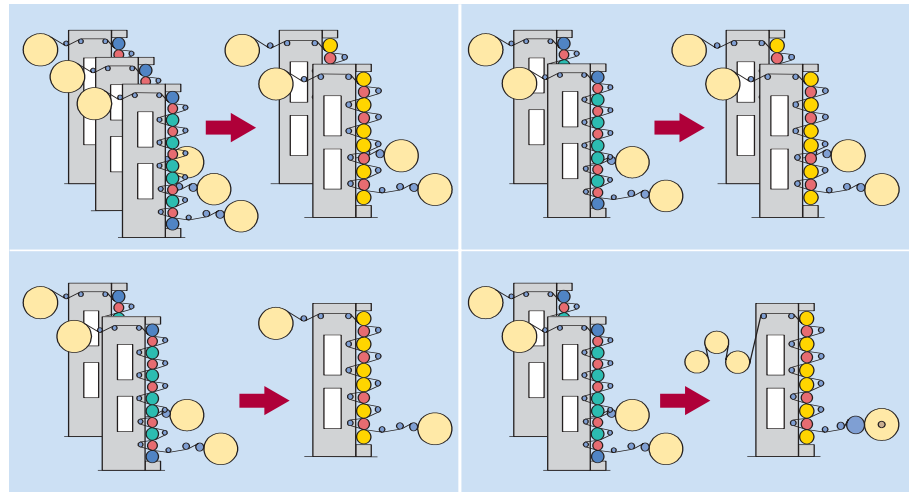

3

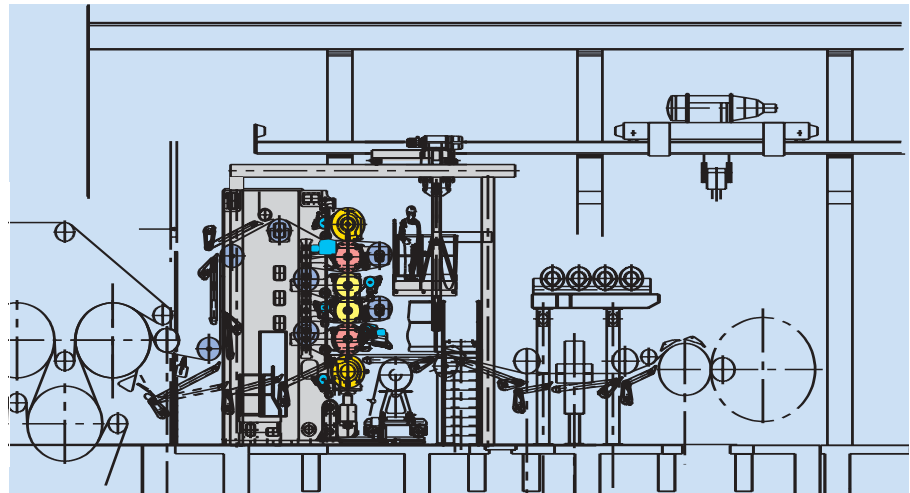

4

Airstream technology brings uncompromisingly high quality results in this connection.

On the left in Fig. 5 is a normal supercalender cotton-covered roll. On the right is the same roll rebuilt with plastic cover and Marun Airstream components. The

main advantage here is not only reutilization of the steel roll core, but above all the resultant optimization of the line force profile in the calender. Fig. 6 shows a comparison between a conventional plastic covered roll and a Marun Airstream roll.

The screwed or welded journals required

Fig. 5:  
Cotton-covered roll conversion into a Marun Airstream roll.

Fig. 6:  
Comparison of line force distributions.

with conventional rolls always cause line force profile deformation extending into the web width. This is due to the stiffening effect of the roll journals, which prevents the oval deformation in the roll centre from extending to the roll ends in the nip. Since the Marun Airstream roll is supported over its entire length on the shaft, deformation variations and line force profile errors are eliminated. Furthermore, these rolls are designed for automatic cooling, which prevents the thermal deformation otherwise affecting plastic rolls (see Table 3).

In fact the Marun Airstream roll is one of the main elements allowing existing supercalenders to be upgraded to Janus technology. It forms the basis for all the various Janus roll cover qualities.

The calender roll surface, particularly of heated rolls which do most of the work in ensuring gloss and smoothness, is particularly important in the Janus concept. As shown in Fig. 7, the roll smoothness is transferred completely to the paper surface gloss.

In order to upgrade an existing calender to this kind of quality, a particularly smooth and glossy roll surface is required which is also wear-resistant. On the other hand, the heated roll must also ensure a temperature high enough for the

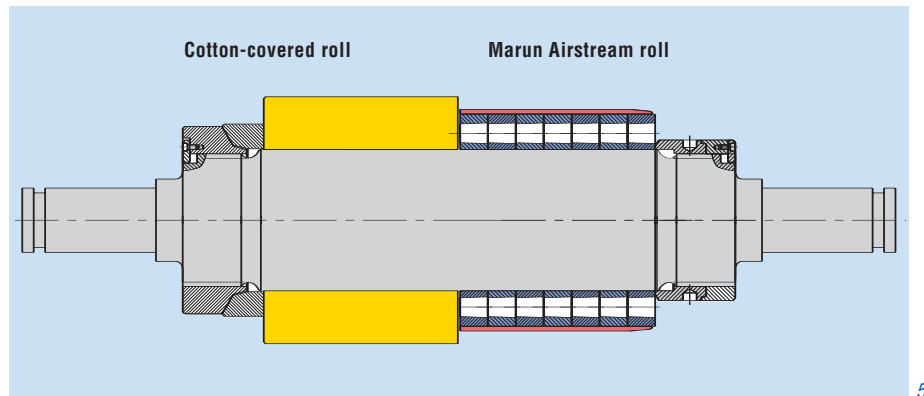

5

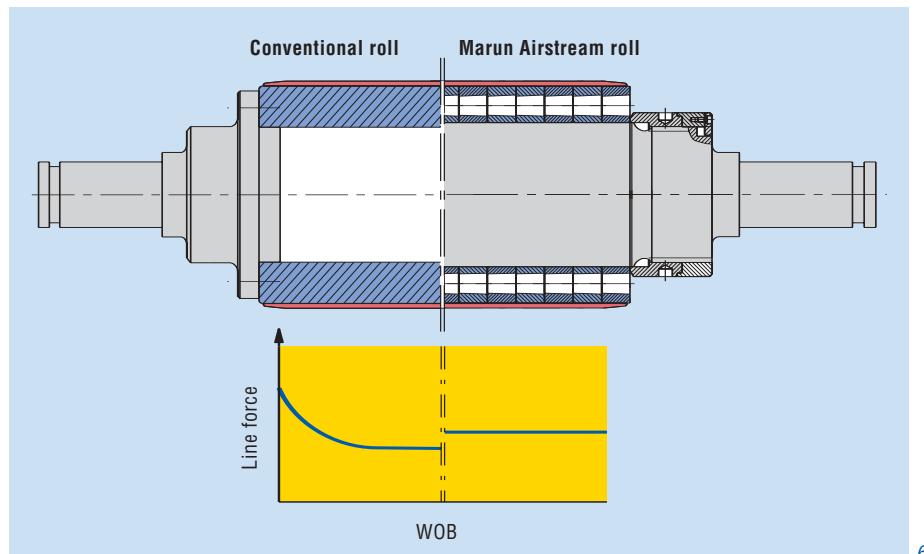

6

Table 3:  
Advantages of the Marun Airstream roll

- Constant deformation over entire width
- Result: constant line force
- Automatic interior cooling
- No heat build-up
- Longer cover life
- Counterbalanced weight: no interference with deformation

necessary calendering quality. Wood-free paper with a well plastifiable surface coating does not require such a high temperature, for example, as uncoated natural rotogravure paper. The surface even of an existing roll can easily be upgraded to the required smoothness with the SumaCal-GD-03 coating specially developed for this purpose. Since most

Fig. 7:  
The calender roll surface smoothness is fully transferred to paper gloss.



existing supercalenders use water heating with a limited temperature range, however, it may be necessary in some cases to raise the temperature, for example by installing single-zone inductive heating using the Power-Coil system.

In other cases it may be possible to attain the required temperature by installing a new steam-heated roll (Fig. 8).

For many years all supercalender operators have been continuously suffered “W-profile” and its effects. One of the main reasons for this line force profile error is the overhung calender roll weight, which can only be countered effectively and above all on a long-term basis by installing counterbalance bearings. The Janus counterbalance bearing modules can easily be retrofitted to existing calenders, as has already been done in several cases (Fig. 9).

The opportunity can also be taken here for eliminating other problems, such as roll nip guard plates. These have to be fitted extremely closely to meet today’s safety requirements, but unfortunately this not only leads in many cases to colossal time delays, but may also cause roll surface damage. By installing a new Janus calender, this problem is eliminat-

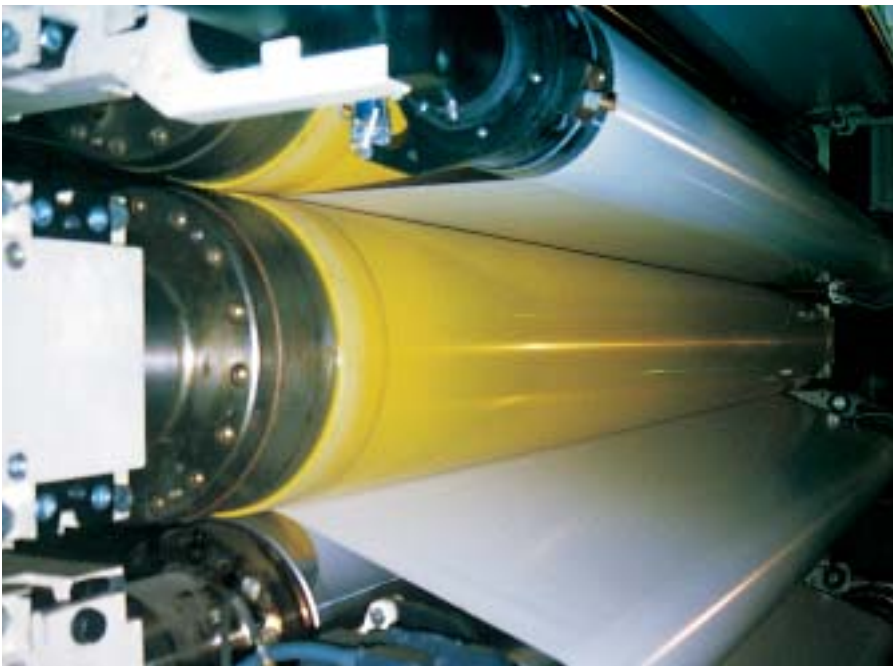
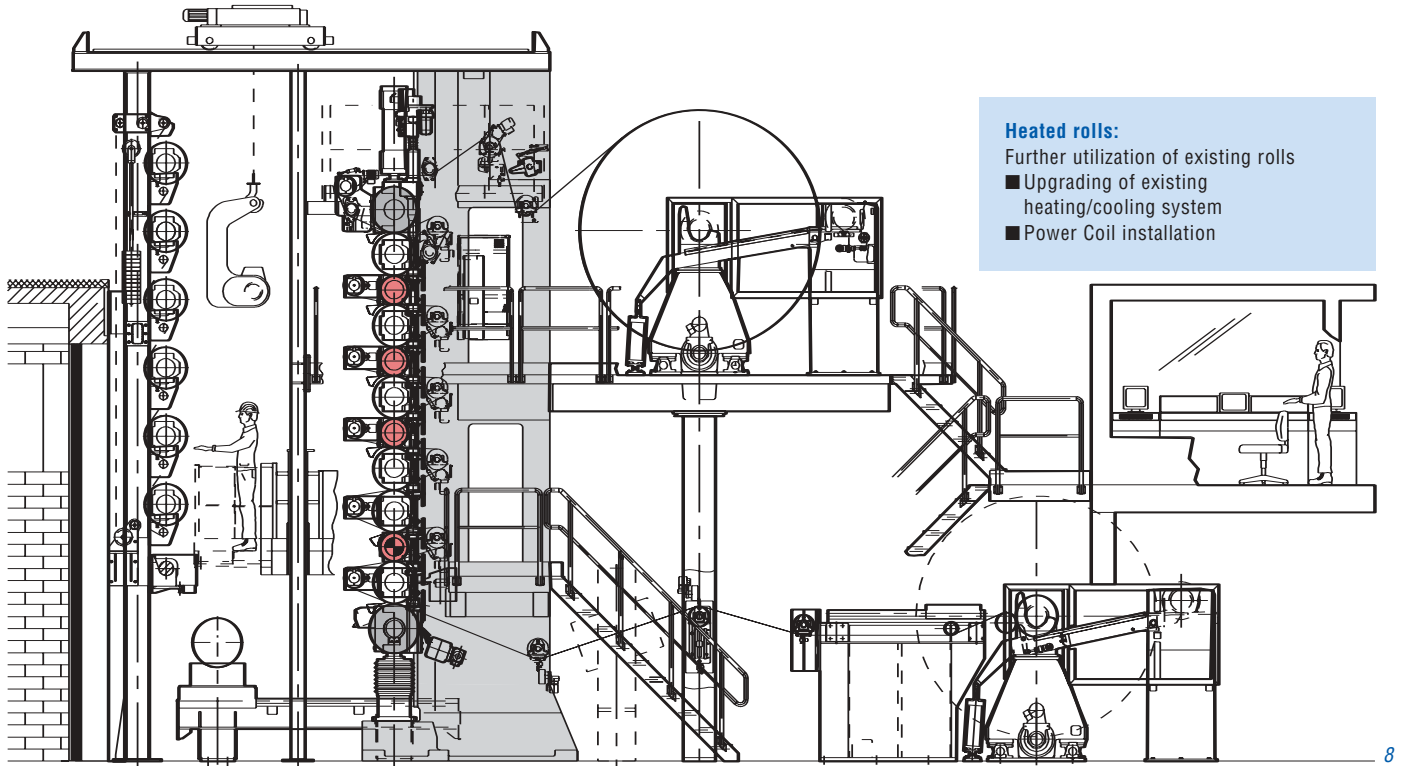

Fig. 8:  
Heated rolls.

Fig. 9:  
Leversupported bearings on all rolls.



ed by installing one rope threading system for the web – a method which can also be used for rebuilds.

As mentioned, one reason for a rebuild to Janus may be higher operating speeds – which immediately raises the question of existing drive capacities. Fig. 10 shows how drive power requirements are affected by web compressibility. Drive power requirement rises roughly linearly with basis weight increase.

Drive power requirement is also affected by roll fillings or roll covers, however, and in this respect the Janus plastic roll

cover demands only 72% of the power required by a blue denim roll filling. Compared with cotton-filled rolls, only about half the drive power is required.

Fig. 11 shows power measurements on a supercalender 8.7 m wide for LWC paper using blue denim roll fillings.

As shown in the diagram, the proportion of energy consumed by paper compression is relatively low due to the low basis weight. The great majority of power (almost 250 kW) is consumed by the blue denim roll fillings. According to Fig. 10, therefore, about 70 kW less power would



Fig. 10: Comparison of drive power consumption by paper and roll cover compression.

Fig. 11: SNC Timavo. Filling material: blue denim  $F_Q = 54 \text{ g/m}^2$ ;  $Q_{UW} = 310 \text{ N/mm}$ .

Fig. 12: Janus Maastricht. Cover material: Janutec  $F_Q = 250 \text{ g/m}^2$ ;  $Q_{UW} = 340 \text{ N/mm}$ .

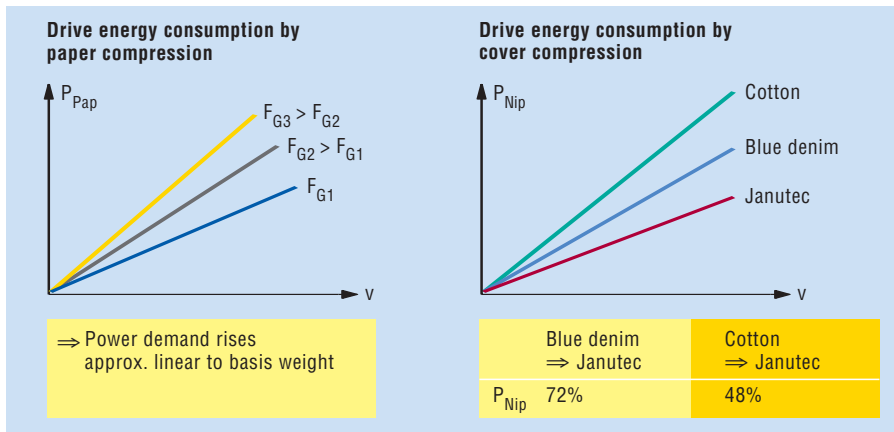

10

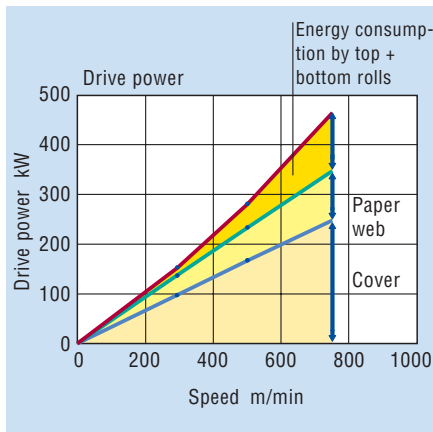

11

be required after a rebuild to higher speed using Janutec plastic rolls. Since every supercalender drive is designed for worst-case conditions – new filled roll condition with maximum diameter, lowest hardness and thus highest power consumption – reserve power capacity in this case is at least enough for speeds well over 1000 m/min.

Fig. 12 shows how power consumption

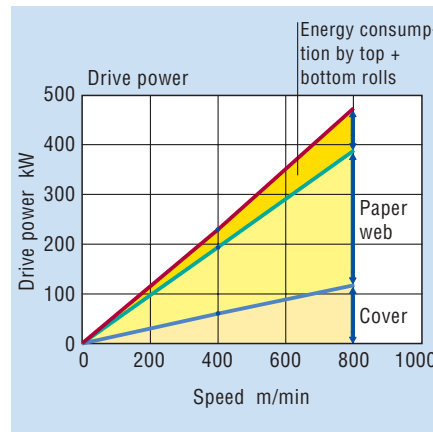

12

was reduced by Janutec covers on an existing Janus calender for wood-free coated paper with basis weight 250 g/m<sup>2</sup>. In this case the relatively heavy web consumes most of the power, while roll cover energy absorption only accounts for about 100 kW.

Diagrams 11 and 12 also show the power component due to the top and bottom

roll compensation rolls. This also has to be taken into account for a rebuild to Janus, irrespective of the existing technology or roll supplier.

All kinds of Voith Sulzer rolls can be used – such as S-rolls, Hydrein rolls or Nipco rolls – as well as other makes, although technical modifications may be required to the rolls or control system.

Attempts have been made for many years toward automatic cross-profile regulation of web thickness, gloss and smoothness on multi-roll supercalenders – but nearly all these attempts ended in failure, because the rolls used in supercalenders get deformed after long periods under load and produce exactly the opposite effect.

Since the Janutec plastic roll covers used in Janus calenders eliminate this undesirable characteristic of conventional roll materials, optimal cross-profile regulation is now possible for the first time in multi-nip calenders, including supercalenders rebuilt to Janus. Table 4 shows two examples of this.

With most Nipco rolls, retrofitting is possible for 2 x 12 = 24 zones in one type and 2 x 30 = 60 zones in the other. For



Fig. 13:  
Existing supercalender (3) for SC papers.

Fig. 14:  
Janus calender rebuild from supercalender.

Table 4:  
Possible number of zones for roll  
rebuild to Nipcorect

#### Nipco rolls

- Additional zones by inserting new tube bundle
- Maximum number of zones depends on dia. of central bore, e.g.:  
90 mm dia. ⇒ max. 12 zones  
130 mm dia. ⇒ max. 30 zones (per side)

#### Hydrein rolls

- Additional zones by inserting tubes in each boring
- Old rolls ⇒ 4 x previous number of zones
- New rolls ⇒ 2 x previous number of zones

Hydrein rolls, the maximum number of retrofitable zones is generally limited to 24. The resultant overall zone width gives a substantial quality gain over the cross-profile, however.

Fig. 13 shows one of three supercalenders for SC papers in a German mill. Fig. 14 shows how these calenders would look after rebuilding, using all the Janus modules.

The calendering speed possible after rebuilding is so high that not only can

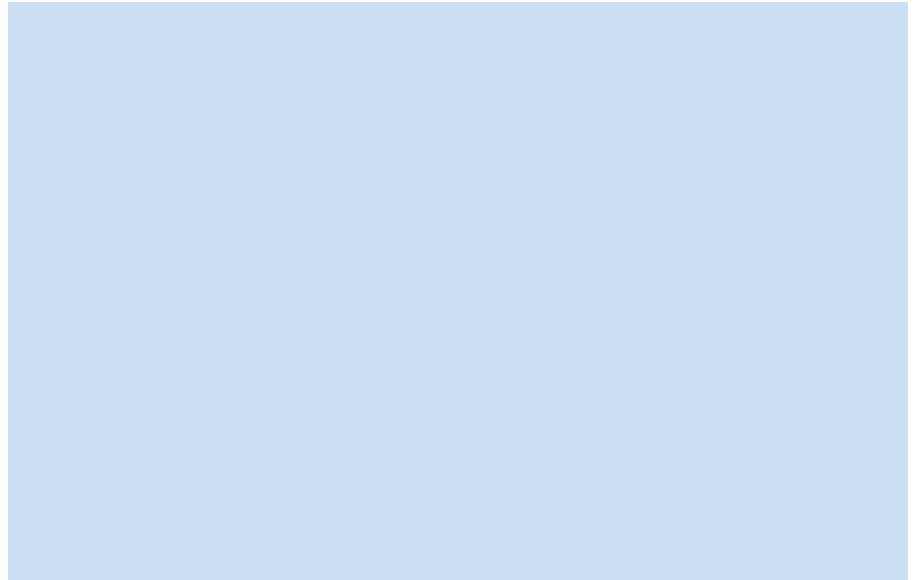

13

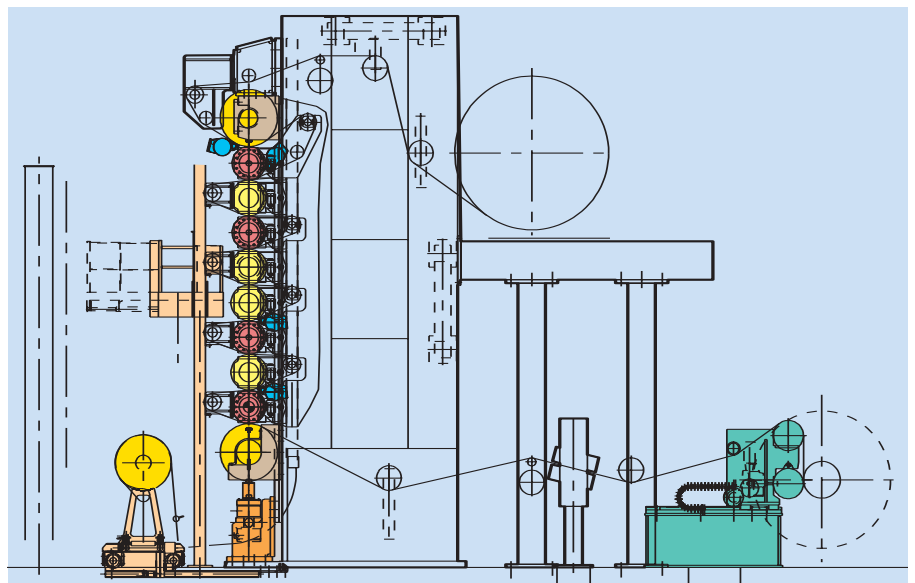

14

one calender be shut down straight away, but the other two still have substantial reserve capacity. With comparable smoothness after calendering, gloss would increase by 7 points at 50% of the speed increase, with significantly higher opacity, appreciably higher volume – and a dramatic reduction of the black calendering effect affecting natural rotograv-

ure papers.

All in all, our title question can therefore be answered in the affirmative – Janus technology can definitely be used for old calenders, with excellent results.



## Finishing Division: Calender rebuild to Janus – economical aspects



*The author:  
Richard Meuters,  
Marketing and  
Division Coordination,  
Finishing Division*

Now that the Janus concept is so well established that it is always considered during the planning procedure for new finishing plants, a publicity campaign entitled “Calender rebuild to Janus” was launched at the beginning of 1997 for existing supercalenders and soft

calenders. With 2-phase mailings to more than 1600 decision-makers in the paper industry worldwide, the feedback rate of more than 10% shows the enormous interest in this promising concept.

Apart from these mailings, the campaign was launched with a „Rebuild symposium“ to inform Finishing Division

employees and European representatives on calender conversion to the Janus concept. For our customers in the paper industry, we are holding further workshops worldwide where rebuild possibilities will be explained in detail to calender operators. Response to our first workshop of this kind in Krefeld for German-speaking customers was overwhelming.

Apart from technical and technological features, one of the most important decision criteria of rebuild possibilities for existing calenders are of course the economical aspects involved.

The main questions to be answered in this connection are as follows:

- What customer benefits does an investment in the Janus concept bring?
- Which are the main cost/benefit aspects?



In this article the general costs/benefits to be considered are explained systematically. Main emphasis here is not on cost/benefit analysis for a specific case, since such an individual approach does not deliver generally valid results.

The economic benefits of the Janus concept are therefore examined here on the basis of categories and criteria. Furthermore symbols are introduced to show favourable or unfavourable effects.

### Categories

The cost-effectiveness of calender rebuild to Janus greatly depends on whether the paper manufacturing process is altered thereby. In contrast to the classical supercalender concept, Janus calenders can be installed offline as well as online in the paper machine or coating aggregate.

Calendering can therefore remain offline despite supercalender rebuild to the Janus concept, or be converted thereby into an online process. Furthermore an online soft calender can be converted into an online Janus calender. The three rebuild categories are as follows:

Category 1	
Category 2	
Category 3	

**Symbols**

The customer benefit of a rebuild to Janus is not presented here in terms of cash figures but symbolized as follows:

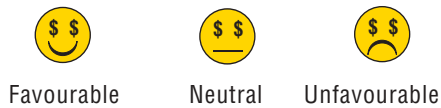

calender not only involves additional space requirements (if structurally possible), but also additional infrastructure costs such as crane, supply piping, spare parts, etc.

A rebuild to Janus is also much more favourable with regard to operating costs – all the extra energy required for the third calender is saved. And Janus calenders run on low-cost primary energy: steam heating instead of water. So the losses associated with converting electrical or fossil energy are eliminated.

**Category 1: offline to offline**

*Example: In a mill with two supercalenders, a third calender is required due to a planned increase in paper machine speed. Alternative: rebuild the two supercalenders to Janus!*

Despite the modest extra power consumption due to higher operating speed, the overall energy savings are a very good reason for a rebuild to the Janus concept.

**Criteria**

Among the numerous cost/benefit criteria for investment assessment, the three most important ones are listed below:

- Investment costs
  - Direct
  - Indirect
- Operating costs
  - Energy
  - Human resources
- Production and pricing
  - Output
  - Prices

Case analysis based on the above criteria:

A rebuild naturally involves direct investment costs. Apart from the purchase price procurement – which may well exceed the purchase price of a third supercalender – standstill costs must also be considered, although these can be significantly reduced by successive conversion.

The human resources required for calender operation are significantly reduced by conversion to Janus. On one hand the extra shift otherwise required for the additional supercalender is not needed. And on the other hand far fewer personnel are required than for two conventional supercalenders thanks to the greatly reduced roll changing frequency (mark-resistant plastic rolls instead of conventional rolls) and the threading devices used in the Janus concept. Furthermore, the Janus concept eliminates components requiring high operating and maintenance outlay, such as spindles and nip guards – again reducing labour costs.

With regard to indirect investment costs, however, a rebuild to Janus is clearly more favourable. Installing a third super-

Fig. 1

Category 1		offline to offline		
<b>Cost-effectiveness</b>				
Investment costs	Direct	☹️	Indirect	😊
Operating costs	Energy	😊	Labour	😊
Production and prices	Output	😊	Prices	😊
<b>Result</b>	😊			<b>Customer benefit thanks to cost savings</b>

As far as production output is concerned, the cost-effectiveness of a rebuild investment is just as favourable. Although speed increases are limited if existing main drives are not replaced, Janus technology allows significantly higher calendaring speeds. This not only eliminates the need for an additional supercalender, but generally gives capacity reserves for increasing paper machine and calender speeds later on.

With regard to paper quality and attainable market prices, there are no significant differences between supercalenders and Janus technology.

Fig. 1 shows how criteria are met for rebuilds in category 1.

**Results:** All in all, an offline to offline rebuild gives greater customer benefit than installing an additional supercalen-

der. This is because of the cost reductions possible, above all operating costs.

Another example in this category is also interesting: by converting one of his two supercalenders to Janus, a paper manufacturer may be able to shut down the first one entirely. In the same way as in the previous example, the advantage here lies in a substantial reduction of operating costs.

**Category 2: offline to online**

*Example:* In a mill with two offline supercalenders or a 3+3 roll offline soft calender, a Janus calender is installed online with the paper or coating machine.

Here again, apart from direct investment costs standstill outlay is involved, which negatively influences cost-effectiveness.

Furthermore, indirect investment costs arise since the dry section must be converted (shortened) or the pope roller repositioned to make room for the Janus calender.

The great advantage of this rebuild again lies in the resultant energy cost savings.

Apart from the aforementioned cost advantage of steam heating instead of water, winding and unwinding power consumption is entirely eliminated. And with continuous online operation, the substantial energy wastage due to acceleration and braking of an offline calender is also eliminated. The entire process heat from the paper machine and coating aggregate can be utilized, so that calender heating requirements are significantly reduced.

Personnel requirements for an online Janus calender are minimal. Calender operation and maintenance are generally taken over by the existing paper machine crew, thus reducing labour costs enormously.

With regard to production output, Janus calenders are generally compatible with today's paper and coating machine speeds. Furthermore, a rebuild to online Janus deals very effectively with the question of finishing capacity for future needs on existing paper machines and coating aggregates.

The critical parameter when a supercalender is replaced with an online Janus calender is calendaring quality, which basically depends on the number of nips. In the past, the inadequacy of multi-nip calenders for online processing was why online soft calenders were limited to one or more 2-roll stacks.

Thanks to Janus technology, this problem is now a thing of the past. Due to the modular concept, a wide variety of roll configurations – from single nip to 8-nip operation (2 x 5 rolls) – is not only possible but already realized. The flexibility of the Janus concept thus ensures that the quality attained by an offline calender can be reached by an online Janus for the majority of paper grades.

This means that attainable market prices are equal to those with offline qualities – but production costs are much lower than prior to rebuild.

An important point in this connection is that the Janus concept also allows greater calendaring flexibility. Whatever the configuration, single nips or any number of nips can be individually controlled for any desired gloss and smoothness, whether 1-sided or 2-sided. This allows fast and flexible adjustment of product quality to changing market demands. In recessive times, competitive chances can thus be improved through superior quality of standard paper grades

Fig. 2

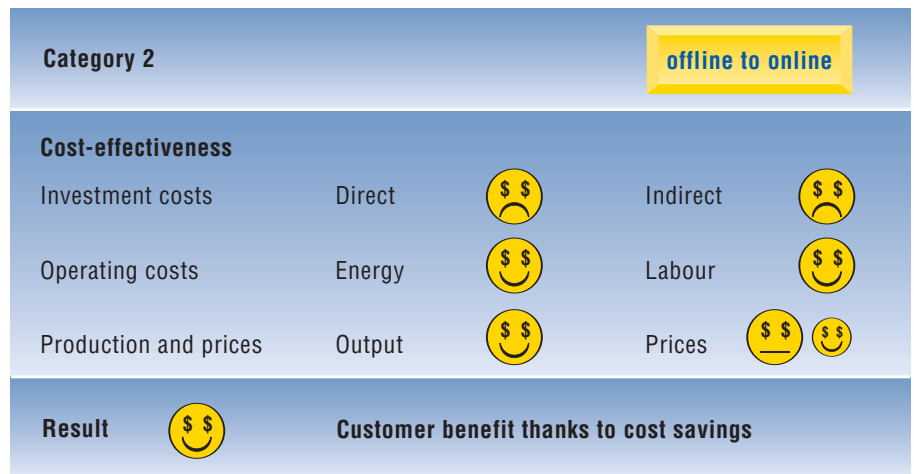

without increasing production costs significantly.

Fig. 2 summarizes assessment results for rebuilds in category 2.

Results: Likewise rebuilds to Janus in the offline to online category bring substantial customer benefit, thanks to operating cost reductions.

**Category 3: online to online**

*Example:* A 2+2 roll online soft calender is converted into a 1 x 6 roll Janus calender.

Apart from the direct investment costs already mentioned, there are no indirect costs in this case since space for the online calender is already available.

Here again, energy costs are substantially reduced. The soft calender with its “open” heating rolls radiates thermal energy continuously. The heating energy required for single nip calendaring is particularly high – and expensive.

Radiation losses therefore cause high costs, last but not least in view of resultant shop heat which has to be removed through the air-conditioning system – which also requires energy. It is not by chance that this type of calender is often referred to as an “energy killer”.

By converting online soft calenders to the Janus concept, these excessive costs are reduced in two ways. First of all the roll surface temperature is lower, so that here again, steam heating can be used instead of oil or electricity. Secondly, the heating roll diameters are much smaller and heat two nips at the same time. And since the

Fig. 3

Category 3		online to online		
<b>Cost-effectiveness</b>				
Investment costs	Direct	☹️	Indirect	☺️
Operating costs	Energy	☺️	Labour	☹️
Production and prices	Output	☹️	Prices	☺️
<b>Result</b>	☺️ <b>Customer benefit thanks to higher prices</b>			

calender rolls are covered with paper anyway, heat radiation is much less.

Rebuilding an online soft calender to online Janus has practically no effect on personnel requirements or production output.

The critical parameter for cost-effective conversion from online soft calender to online Janus is calendaring quality. As mentioned, Janus calenders achieve the same gloss and smoothness results as supercalenders, depending on the number of nips.

So in the present example a newsprint soft calender can produce SC-B grades or better after conversion to Janus (and suitable paper machine modifications). A glance at a paper price list is enough to show what this means in terms of financial returns.

In this case, for example, annual turnover would rise by more than 1 million DM for one paper machine alone! Since this extra income – thanks to the Janus concept – is possible at about the same costs as for online production of standard grades, the financial advantages are obvious.

Fig. 3 summarizes results for category 3.

Results: In contrast to the other categories, customer benefit with an online to online rebuild lies not in cost savings but in value added – and therefore in higher product prices.

After investigating all three categories, the original question as to rebuild cost-effectiveness can be answered as follows: Whatever the rebuild category, the investment is always worthwhile. Either in terms of operating cost savings, or in

terms of higher prices due to higher product quality at the same manufacturing costs.

Every rebuild project in practice – and a good many are now underway – has its special features which affect individual aspects of the general economics investigated in the above.

The real scope of rebuild varies according to existing calender equipment, likewise local energy and labour costs affect the breakeven point. For operators of double and triple calender configurations, however, the advantages of a rebuild to Janus should be checked.

In summary, all existing calenders can be converted to the Janus concept – soft calenders as well as supercalenders. And this applies not only to Voith Sulzer calenders but also to all other.

By the way: during the course of 1997 three supercalender rebuilds to Janus will go into operation.

## Service Division: Potential in Europe



*The author:  
Kirsten Kolvenbach,  
Marketing  
Service Division*

Maximum plant availability and optimal paper quality – two major goals of the pulp and paper industry which are often hard to achieve. So many factors affect the production process that new problems, both large and small, have to be solved every day in routine maintenance as well as emergencies.

The Voith Sulzer Paper Technology Service Division is on standby for such prob-

lems – 365 days per year round the clock. According to our strategy “global resources – local response”, the Service Division is represented in the main paper producing regions.

Apart from the various Service Centres in North and South America, Europe’s large pulp and paper industry is supported by Voith Sulzer Paper Technology Service Centres in the following strategic locations:

**Düren Service Centre (Germany)**  
**Heidenheim Service Centre (Germany)**  
**Ravensburg Service Centre (Germany)**  
**Weissenborn Service Centre (Germany)**  
**St. Pölten Service Centre (Austria)**  
**Kriens Service Centre (Switzerland)**

In addition, further Service Centre locations are planned in Scandinavia and Southern Europe.

The services offered by these centres are impressively comprehensive. They include complete servicing of all plant and machine components, whatever the make or type. And whether for maintenance or repair, conversion or modernization: together with the customer and other Voith Sulzer Paper Technology Divisions, our specialists always work out the optimal solution according to specific needs.

For efficient problem-solving, thorough analysis by appropriate measuring methods is indispensable. Apart from troubleshooting, a plant condition analysis is

Fig. 1:  
Service Centres in Europe.

Fig. 2:  
A large paper machine roll for balancing.

Fig. 3:  
Machining the centre seating of a suction roll sleeve.



carried out or possibilities are investigated for optimizing the production process and product quality. Furthermore, permanent condition monitoring enables preventive maintenance measures, thus preventing consequential damage.

For plant conversions or modernizing individual components, our service specialists can be called in right from the outset in an advisory capacity. They bring with them not only outstanding know-how, but also the latest machining equipment. Even the largest rolls can be ground and resurfaced – because the range of service centre facilities is just as wide as the variety of roll diameters, widths, materials, surface finishes and weights. From balancing to journal repairs, our roll services are fully comprehensive.



Likewise for field repairs, our Service Centres are equipped with the very latest in mobile facilities. For example: in-situ roll grinding on the paper machine can be carried out to high precision in a very

short time. Likewise for field thermal spray coating, our modern equipment guarantees absolute uniformity. And with our special-purpose vacuum extraction equipment, environmental hazards and human risk are eliminated.

Through the Voith Sulzer Paper Technology Service Division, customers profit from the entire Group resources in know-how and manufacturing facilities – just contact your nearest service centre.

To find out more about the facilities offered by our European Service Centres, read on:

### Düren Service Centre

The Düren Service Centre people have a reputation for fast and personal help in emergencies. One of the latest examples



*Fig. 4:  
Suction roll test rig.*

*Fig. 5:  
Polar coordinate display of balancing  
characteristics.*



4

of this was a breakdown caused by roll sleeve damage in a high-load press. Shortly after the customer called at 10 a.m. on a Sunday morning, our service centre specialists were on the spot with all the equipment required for roll dismantling. At the same time a reserve roll was prepared in the Service Centre and transported to the mill for installation in the press. At 6 p.m. on the same day the paper machine went back on line without problem.

Another example: the Düren Service Centre offers grinding capacities up to almost 100 man-hours per day, so that several rolls can be refurbished simultaneously with relatively short downtimes. The Düren facility and know-how can handle all roll sizes, from the smallest to the largest.

#### **Heidenheim Service Centre**

Located directly at the centre of competence (COC) for printing/writing paper machinery, Heidenheim Service Centre can access the latest findings to the benefit of customers. For refurbishing suction rolls, for example, modern developments can be put into practice right down to the last detail: conical cover seatings for reduced dynamic loading, oil lubricated suction box bearings for greater reliability, etc.

After suction box overhaul, a test run is made on a special rig to check the sealing bars in particular. This ensures optimal running of the reinstalled roll. Dynamic balancing in three planes with graphical display of results is another service at the Heidenheim Centre. Thanks to modern balancing machines, this results in ex-

5

tremely smooth running and outstanding operational behaviour, even at the highest speeds.

#### **Ravensburg Service Centre**

Monitoring systems at the Ravensburg Service Centre are the latest way of keeping check on the production process and plant condition. These systems, which can be individually configured to suit plant needs, enable systematic problem analysis and diagnostics as a basis for condition based maintenance. The ultimate goal is to optimize paper quality and maximize machine availability.

Instead of completely replacing tissue and MG cylinders, the Reshelling procedure recently developed at the Ravensburg Service Centre refurbishes only the shell

Fig. 6:  
Machining a JANUS CONCEPT roll.

Fig. 7:  
Condition monitoring system.



6

and if necessary the inner condensate drainage system.

In addition to general maintenance and overhauls, the Ravensburg Service Centre specializes in NIPCO rolls. To ensure full functionality of these rolls after refurbishing, a NIPCO test facility is available for checking operation and sealing. The modern CNC grinding machines here enable optimal high-precision grinding, even of the coated SUMEcal GD rolls used in the JANUS CONCEPT.

#### Weissenborn Service Centre

Apart from detailed services such as roll grinding or component repairs, the Weissenborn Centre also undertakes complex long-term service orders for total plant maintenance. This strategy has been im-

plemented successfully for some years now in various paper mills.

The Weissenborn Service Centre also repairs and installs all kinds of paper machinery components, including pipework and pumps. Services range from diagnostics to final condition assessment after the completion of repairs and installation.

For customer support in case of planned shutdowns, the Service Centre carries out pre-checkups. Three or four weeks prior to shutdown, the condition of key components is checked. Based on results, recommendations are then made for systematic repair or optimization measures.

Technical diagnostic methods round off the services provided by the Weissenborn Centre, enabling details such as on-site

7

fan balancing and conditional monitoring of roller bearings during operation.

#### St. Pölten Service Centre

The world record paper machine in Braviken is equipped with an important component emanating from the St. Pölten Service Centre: the GR roll cover of the future. As an alternative to granite rolls or synthetic covers, ceramic covers are ideal for all press types and all kinds of furnish – including those with high waste paper content.

Thanks to its outstanding characteristics – such as significant reduction of paper tension and tearing – the GR roll cover can stay in service for many years without grinding. If required, the St. Pölten Service Centre can supply GR covers complete with roll.

*Fig. 8:  
Grinding a GR ceramic roll coating.*

*Fig. 9:  
On-site thermal spray coating.*



8

The St. Pölten Centre also provides on-site coating services for poperollers and reels, using portable sandblasting and thermal spray technology equipment. For intermittent removal of deposits from roll surfaces, multiple sand blasting can be carried out. The type of surfacing is optimized according to paper grade, thus ensuring maximum grip and longest possible service life of the raw surface by spraying with extremely hard materials. This results in uniform winding hardness and structure.

#### **Kriens Service Centre**

Customer support services in Kriens include not only expert consulting and troubleshooting, but also well-versed paper machinery erection staff to assist plant personnel during planned shutdowns and/or conversions.

The Kriens Centre also provides services such as roll balancing and complete overhaul or repair of plant components.

In the case of suction rolls, for example, the customer can select the service elements required for his specific needs – from bearing diagnostics to comprehensive overhaul and repairs, including new paintwork inside and out.

Likewise customers outside the paper industry are served by the Kriens Centre, resulting in valuable synergies from the experience and know-how gained in this connection.

Another product of the Kriens Service Centre is the well-proven BELL line of vacuum pumps and compressors. Services in this connection range from complete

machinery and spare parts deliveries to works servicing or on-site overhaul.

This summary of the services provided by our individual centres gives some idea of the vast potential of the Voith Sulzer Paper Technology Service Division.

Whatever your needs, it is only necessary to contact the nearest Voith Sulzer Paper Technology Service Centre. You will then benefit from the know-how and potential not only of our service division, but of the entire Voith Sulzer Paper Technology Group.

9



*The authors:  
Mr. Zhao Juntal,  
Chairman of the  
Board, LVSC;  
Heinz Appenzeller,  
General  
Manager LVSC;  
Walter Müllner,  
Voith Sulzer  
Paper Technology,  
chief representative  
in Beijing.*

## China:

### Joint venture in China – Liaoyang Voith Sulzer Paper Machinery Co. Ltd.

The close cooperation between Voith Sulzer companies and Liaoyang Paper Machinery Co. Ltd, in the north-east China province of Liaoning, started in 1986. At that time J.M.Voith AG, St. Pölten/Austria – responsible then for Group paper machinery marketing in the P.R. of China – was looking for a joint-venture licensee among leading Chinese paper machinery firms.

Negotiations were held with the Ministry of Light Industry, the Ministry of Foreign Trade and Economic Cooperation (MOFTEC), and the China National Import and Export Corporation (CNTIC).

The Liaoyang Paper Machinery Works (LPMW), as it was then called, was recommended as most suitable partner.

In 1987 LPMW signed a licence agreement with J.M. Voith AG for manufacturing packaging paper and board machinery components in the People's Republic of China.

From 1986 to 1997, no fewer than nine large orders were completed on this basis for the Chinese paper industry, with equipment made in China worth around 250 million RMB (30 million US\$) and imports worth around 50 million US\$.

Fig. 1:  
Liaoyang city centre.

Fig. 2:  
Multi-fourdrinier board machine in Zhuhai.

Fig. 3:  
Dryer roll, 1500 mm dia.



2

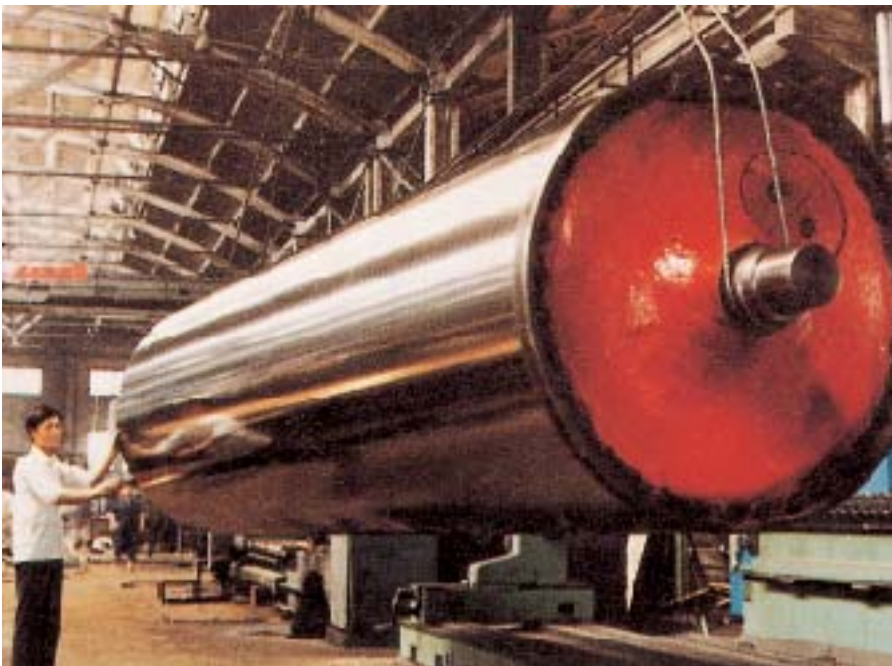

3

These orders included the first Duo-Former H for Jin Cheng paper mills, a linerboard machine for the Wuhu Dong Fang paper mill, several cylinder mould former carton machines, and multi-fourdrinier board machine for Hongta Renhang mills in Zhuhai.

Based on these positive results with LPMW and in view of Chinese market development potential for packaging and board machinery, Voith Sulzer Paper Technology approved a joint venture in 1994 between J.M. Voith AG and Liaoyang Paper Machinery Co. Ltd for marketing and manufacturing dryer sections and rolls. Apart from the expected growth of paper consumption in the People's Republic of China and the associated import of very large production aggregates, a decisive aspect here was the urgent need for modernizing or replacing small to medium size machinery at reasonable cost.

Clearly this need could only be met through adequate production of paper machinery components in China with modern know-how. Negotiations therefore started in 1994, and the new joint venture was signed in March 1996.

After the necessary permits and business licence had been granted by Voith Sulzer Paper Technology and the Chinese authorities, this joint venture agreement finally came into force on March 20, 1996.

*Fig. 4:  
Dynamic balancing machine.*

*Fig. 5:  
Vertical boring mill.*

*Fig. 6:  
Press section of a board machine in Zhuhai.*

J.M. Voith has a 60% share in this joint venture, with total assets around 17 million US dollars.

The LVSC headquarters and plant buildings are set up on a 25,000 m<sup>2</sup> site right next door to Liaoyang Paper Machinery Co. Ltd. Apart from a small administration building for the company management, sales department, financial and technical departments, the three machine shops cover an area totalling 10,000 m<sup>2</sup>.

One shop is equipped for machining dryer rolls and other heavy workpieces up to 32 tonnes (max. casting weight 25 t). Rolls up to 8000 mm wide and 2200 mm dia. are machined and dynamically balanced here, likewise small tissue rolls up to 3600 mm dia. and 3800 mm wide.

In the second machine shop press rolls and pope rollers are machined in diameters up to 1250 mm and widths up to 12,000 mm, depending on diameter. Here again, maximum workpiece weight capacity is 32 tonnes.

The third shop is for works assembly and dispatch. Raw castings for dryer cylinders are supplied by the LPM Co. Ltd foundry, which is being modernized and expanded to improve quality and enable roll castings up to 1800 mm diameter and 8000 mm wide. After expansion work is completed, the foundry and roll machine shops will have a mean capacity of



4



5



6

*Fig. 7:  
The Liaoyang Voith Sulzer Paper Machinery  
Co. Ltd. team.*



7

420 dryer rolls per year (depending on diameter and width).

These shops can turn out up to 150 cast rolls and 250 to 300 pope rollers. The sales department of Liaoyang Voith Sulzer Paper Machinery Co. Ltd. (LVSC) works closely with the Voith Sulzer Paper Technology office in Beijing and with the sales departments of Voith Sulzer Paper Technology companies.

Particularly important in this connection is that with our Chinese partner and/or Voith Sulzer Paper Technology companies

as key component suppliers, the LVSC joint venture can deliver complete paper machines.

The important role played in future by LVSC in connection with large Voith Sulzer Paper Technology contracts in China will include the placing of local production which cannot be handled by LVSC or LPM Co. Ltd.

According to current planning, human resources will be expanded to 221 employees in the final phase. Two Voith Sulzer Paper Technology managers are

permanently located at LVSC headquarters, and if necessary they can be supported by additional personnel according to specific requirements.

Liaoyang Voith Sulzer Paper Machinery Co. Ltd. has received tender inquiries for projects in China, Korea, Iran (in connection with Chinese development aid) and from an Austrian/Chinese joint venture. The first small orders have already been booked, and further orders are expected by the time the production plant starts operating in mid-1997. This new company is clearly going to reach its ambitious targets.



Since the announcement in September last year that the NIPCO roll business is to be transferred to Voith Sulzer Finishing, Voith Sulzer Manchester has been undergoing somewhat of a transformation to become the Centre of Manufacture and the new home for NIPCO.

In order to successfully co-ordinate these efforts, Voith Sulzer Krefeld became the Centre of Product, responsible for design and development. Teams were immediately established in both Manchester and Krefeld to organise the transfer of the NIPCO business activities from De Pretto Escher Wyss in Schio, Northern Italy.

This complex move involves taking onboard the technical know-how, re-siting the components and spare parts stock, patterns, tooling, test rig and of course, the manufacturing technology.



*The author:  
Nigel Ashworth,  
Finishing Division*

In becoming the central manufacturing base for all deflection compensating rolls,

Manchester will draw on over thirty years of experience in the design and manufacture of the Swimming roll (now known as Econip). It will also benefit from the

## Great Britain: A new home for Nipco



extensive technical knowledge gained by Voith Sulzer Krefeld during manufacture of the Hydrein roll, which was previously marketed in competition with NIPCO.

Current NIPCO roll production in De Pretto is now tailing off and with completion of the existing contracts planned for June of this year, the final piece in the jigsaw –

the test rig transfer – can take place. To be fully operational in the Manchester plant by the end of September, the new installation will allow comprehensive dynamic testing of the largest of rolls, some of which already form part of the orders now in hand since commencement of production in Manchester (*refer to table*).

Quantity	Customer	Diameter mm	Face mm	Type/Size
3 Rolls	Hansol, Korea	610	5120	F/6
6 Rolls	Port Hawksbury, Canada	980	9680	KLCR/15
2 Rolls	Braviken, Sweden	905	8950	F/13
1 Roll	Hylte, Sweden	1035	8780	F/15
7 Rolls	N. N.	1003	9970	F/15



*Fig. 1:  
The new assembly bay under construction.*

*Fig. 2:*



The contract for Port Hawksbury in Canada is arguably one of the most technically demanding of roll designs built so far. With a total of 54 zones each, these six NIPCORECT rolls will be installed in two new Janus concept calenders. They each employ the latest state of the art Load-ContRoll system for monitoring and identifying disruptive forces in the calender roll stack.

This undertaking by Voith Sulzer Manchester, forms part of its expansion programme which involves a new 1000 square metre manufacturing bay with crange capacity of 80 tonnes for the assembly and testing of rolls. The new bay will also be used to build larger ECOSOFT calenders as a result of extending the range and widths of units supplied out of the Manchester centre. The commitment to manufacture these wider machines will be backed up by a new customer trial facility and paper testing laboratory with



start-up planned for September, 1997. Clients will be able to run a wide variety of paper grades under the most arduous of operating conditions to meet the never ending demands of todays paper maker for continuous improvements in end product quality.

Basic design parameters will be:

Specific nip pressure:	50 N/mm <sup>2</sup>
Speed:	1500 m/min
Surface temperature:	220 deg C

Being accredited to the ISO 9001 quality management system for over 6 years, Manchester will continue to meet internationally recognised quality standards for the design and construction of all deflection compensating rolls and finishing equipment.

In addition, Manchester will also co-ordinate NIPCO roll quotations, tenders and order handling together with the centralisation of spare parts and service arrangements. Extensive component stocking wherever possible, will ensure a fast and efficient turn-round of spare part orders.

A team of service engineers are on hand to offer crucial support around the world and enable the Voith Sulzer Paper Technology service centres to continue to offer unparalleled customer care in a most competitive market.

## USA: Voith Sulzer Paper Technology – rooted in the history of North American papermaking

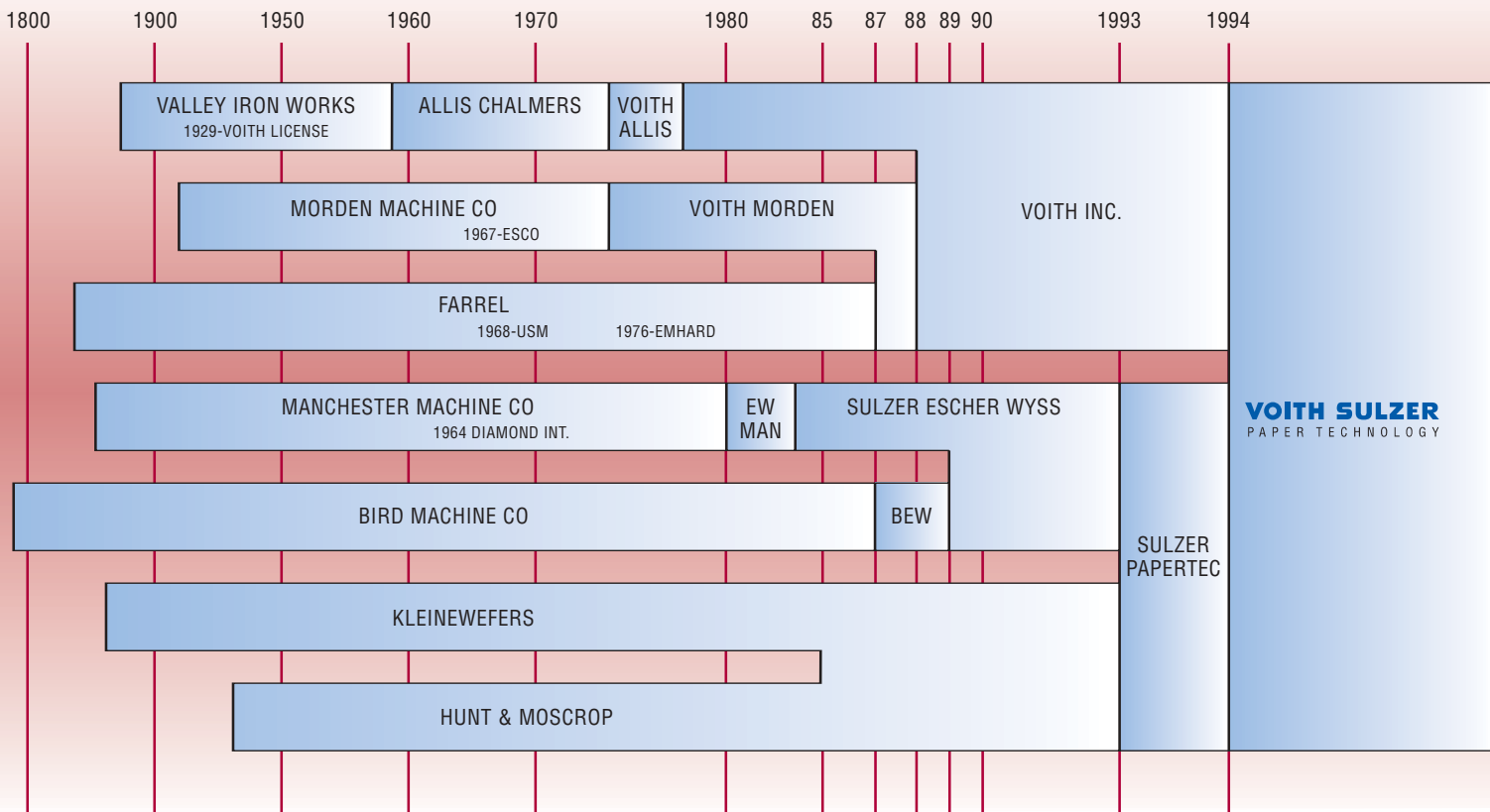

The author: Ralf G. Sieberth, Market & Business Development, Voith Sulzer Paper Technology North America, Appleton

The story of Voith Sulzer Paper Technology is deeply rooted in the development of the North American pulp and paper industry. The origins of most of our products and divisions date back to the end of the last century. Today's presence is built from the vast resources of all our domestic and international founding companies. Ultimately all their talents, knowledge and expertise were combined to form Voith Sulzer Paper Technology North America, a recognized leader in one of the largest industries on this continent.

Our history is deeply rooted in the economic development and pioneering spirit that made the paper industry a dominating industrial force.

### Bird Machine Company

George Washington was only halfway through his second presidential term in office when George Bird opened his paper mill in Walpole, Massachusetts. The small mill located southwest of Boston manufactured printing and wrapping paper. The quality of Bird's mill eventually made them the sole supplier of United States banknote paper.

During the late 1800's, George Bird's grandson, Charles, traveled to Europe and returned with a German papermaking screen. It was the first in America, and it was a great success. By 1909 the Bird

*Fig. 1:  
Bird screen. Built 1936 for Nekoosa Paper,  
Port Edwards .*

*Fig. 2:  
Voith Sulzer Paper Technology in Mansfield, MA,  
today – originating from the previous Bird Machine  
Company.*



1



2

*Fig. 3:  
1978. Preassembly of a press section  
at Manchester Machine Company.*

*Fig. 4:  
Voith Sulzer Paper Technology in Middletown,  
OH, today – the successor to Manchester  
Machine Company.*



3



4

Machine Company secured a license to manufacture the screen and became a leading supplier of screens and cleaners to the American paper industry. In 1987 Sulzer Escher Wyss of Ravensburg, West Germany entered into a joint venture with the Bird Machine Company to form Bird Escher Wyss (BEW). BEW, now located in Mansfield, Massachusetts, would soon become one of the most comprehensive stock preparation suppliers in the world. Two years later, Sulzer Escher Wyss purchased BEW, making it an integrated designer and manufacturer of paper machinery and stock preparation equip-

ment. It also became a major parts and service center.

#### **Manchester Machine Company**

The Middletown, Ohio operation was started in 1860, when manufacturing boomed along the Great Miami River in southeastern Ohio. It manufactured machinery for the paper and tobacco industries, and is one of the oldest continuously operating businesses in the area. In 1949 the company was named Manchester Machine Company. Manchester Machine Company became known worldwide for its Manchester For-

mers, used to manufacture container-board and folding boxboard. Manchester Machine Company also built smaller paper machines and components, including suction rolls, headboxes, presses, calenders and winders.

The present facilities in Middletown, just north of Cincinnati, were built in 1959. In 1964 it became part of Diamond International Corporation, best known in the United States as a manufacturer of safety matches. In 1980 Sulzer Escher Wyss acquired a minority interest in Manchester Machine Company and it was renamed Escher Wyss Manchester. The name was

changed to Sulzer Escher Wyss in 1983 when Diamond International sold their remaining shares.

#### **Kleinewefers and Hunt & Moscrop**

Kleinewefers, founded 130 years ago, had long been known as a supplier of calendars to the paper industry. The successful German company was a leading force in supercalender technology worldwide, with a large market in North America. They had also been advancing softnip calender technology since the early 1980's. The 65 year-old British firm of Hunt & Moscrop had focused their manufacturing on supercalenders, and later helped develop softnip calendars. Kleinewefers acquired Hunt & Moscrop in 1985. In partnership with Kleinewefers, Hunt & Moscrop continued to advance softnip and hardnip calender technology. For the last three decades they have been a major supplier of swimming rolls to the worldwide paper industry.

When Sulzer Escher Wyss purchased Kleinewefers, the Hunt & Moscrop North American office in Atlanta, Georgia was moved to the Middletown facility. The Ohio Sulzer Escher Wyss product line now included the original Manchester paper machinery, Bird stock preparation technology and Kleinewefers, Hunt & Moscrop paper finishing machinery. In 1993 the Sulzer Escher Wyss name was changed to Sulzer Papertec to reflect the acquisitions of the Kleinewefers, Hunt & Moscrop and Bird product lines.

#### **Morden Machine Company**

Morden Machine Company was formed in 1929 by C.W. Morden in Portland, Oregon. Mr. Morden had developed and



*Fig. 5:  
Grinding of a Yankee dryer in the early twenties at Farrel, Ansonia, CT. Today roll grinder manufacturing and service are provided by Voith Sulzer in Appleton, WI.*

patented one of the first conical pressurized refiners, and later developed the first high-shear pulper for the reclamation of wood fibers.

Morden Machine Company became a leading supplier of refiners and pulpers to the paper industry throughout North America. While Morden continued to design and patent machines, they were being manufactured in Washington, Oregon and Oklahoma.

The company was operated and controlled by the Morden trust until 1967, when the company was purchased by Esco Corporation, maintaining the Morden Machine Company name.

The German Voith family purchased a majority interest in Morden Machine Company from Esco Corporation. The name was changed to Voith-Morden and it continued to operate from the Portland office.

In October of 1979, the company's principal place of business was moved from Portland, Oregon to Appleton, Wisconsin. The company was reincorporated in the State of Wisconsin in May, 1982 as Voith-Morden, Inc. At the end of 1988, all

shares held by the Voith family and Esco in Voith-Morden, Inc. were purchased by J.M. Voith GmbH of Heidenheim, West Germany.

#### **Farrel Company**

In the 1840's Farrel Company of Ansonia, Connecticut was manufacturing machine tools for a variety of industries. During the early 1900's, Farrel began manufacturing roll grinders for the growing North American paper and steel industries.

In 1968 the Farrel family sold the company to U.S.M. Corporation. U.S.M. was a large diversified conglomerate that owned companies involved in plastics, gears, shoes and bottle manufacturing machinery. When U.S.M. began to divest their holdings, the Farrel Company was sold to the Emhart Corporation. Throughout the 1970's and 1980's, the Farrel Company became the leading supplier of roll grinders in North America.

Voith-Morden purchased the Farrel Company roll grinder division in 1987, and integrated it into the existing Voith single-wheel roll grinder product line being manufactured in Appleton, Wisconsin.

*Figs. 6 and 7:  
Two views of a headbox from Valley Iron Works,  
Appleton, WI, for Chillicothe Paper Company,  
Ohio. Primary material was cypress wood.*

*Fig. 8:  
Valley Iron Works, Appleton, in 1843. It started  
as a machine and blacksmith shop and today  
Appleton is the North American headquarters  
of Voith Sulzer Paper Technology.*



6

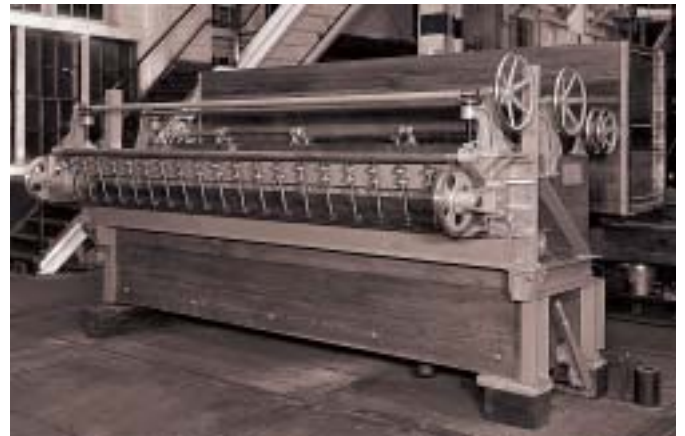

7



8

### Valley Iron Works

Valley Iron Works was started in 1883 as a small machine and blacksmith shop in Appleton, Wisconsin. Its primary products were milling machinery, water-wheels, and other machinery. An interesting historical fact: In September 1882, Appleton was the location of the first hydroelectric central station in the world, installed to provide electricity to com-

mercial and residential customers. Valley Iron Works was incorporated in 1900 and developed into a manufacturer of pulp and papermaking machinery to serve the growing Fox Valley paper industry. Until about 1930, the firm's principal products were beating, screening, and refining equipment.

In the early 1920's Valley Iron Works became the licensed builders of the Voith

Inlet, a specialized design of headbox headers, an important part of fourdrinier type paper machines. Up to this point, the company had produced primarily components for cylinder paper machines. This machine concept began to fall from favor, bowing to the more productive fourdriniers.

In 1945 Valley Iron Works began to produce its own inlet and headbox combina-



9

10



11

*Figs. 9, 10 and 11:  
Voith Sulzer Paper Technology North America in  
Appleton, WI, today. Aerial view (with the  
Recycling Technology Center in the background)  
and machine shop.*

tions. The Valley Headbox continues to be so popular that today over 1,200 headboxes in North America bear the Valley nameplate.

Valley made these and other paper-machine sections until it was decided in 1958 that the organization was ready to market its first complete machine. The first order, received late that year, went to Nicolet Paper Company of West DePere, Wisconsin, and the firm continued to produce complete paper machines since that time.

Valley Iron Works changed its name after the purchase by Allis-Chalmers of Milwaukee, Wisconsin in 1959. The change in names continued until 1974, when Allis-Chalmers entered into a joint venture with J.M. Voith GmbH, creating the Voith-Allis Corporation. Only three years later, Voith purchased the remaining shares from Allis-Chalmers and the organization became Voith, Inc., Appleton.

#### **Voith, Inc.**

With the incorporation of the Voith, Inc., a new office and manufacturing facility was built in Appleton's Northeast Industrial Park, to meet the increasing demands for paper machinery. The primary products of this greenfield facility were the new generation of Valley headboxes, and the widely known Voith W-type hydraulic headboxes. Within a short time, the company had expanded from a service center to a highly successful, fully equipped engineering, manufacturing and service organization.

In 1988, after eleven years of steady growth and several major expansions, the

Voith Inc. paper machine business was combined with Voith-Morden. The addition of the Voith-Morden stock preparation and roll grinding divisions meant Voith Inc. could now offer their customers a complete line of products, from fiber treatment through papermaking and finishing, from one company.

#### **All Together Now**

On October 1, 1994, J.M. Voith GmbH and Sulzer AG merged their paper machinery businesses into a joint venture, named Voith Sulzer Paper Technology. It was the culmination of a process and the realization of a new global company that crosses cultural and geographic boundaries to deliver the highest quality products and service to our customers. The entrepreneurial spirit of the North American paper industry pioneers was successfully merged with European technology for the benefit of a concentrated, more effective North American presence.

Today, complete paper machines and components are manufactured primarily at two locations, Middletown, Ohio and at the Voith Sulzer Paper Technology North American headquarters in Appleton, Wisconsin, which is located only a few miles from the original Valley Iron Works site. Many of the technologies developed by Bird and Morden Companies are still incorporated into our stock preparation equipment. The merger of the product lines and research facilities provides Voith Sulzer customers with the most comprehensive line of pulping and deinking systems in the world.

In keeping with the combination of extensive experience and a long time tradition of technological innovations from both

Farrell and Voith Sulzer designs, our roll grinders continue to be developed as well as manufactured in Appleton, Wisconsin. Advanced technology design permits full automation, including automatic roll loading. These machines have retained their leadership position in both the worldwide paper and metals industry.

The Voith, Sulzer Escher Wyss, Kleinfefers and Hunt & Moscrop technologies have been combined to deliver the world's finest finishing equipment to Voith Sulzer customers.

An efficient network of five service centers span the North American continent. Each center is fully equipped to perform all types of repairs and service. This includes roll and machine component rebuilds, as well as the maintenance and repair of pulp processing and stock preparation components.

Together, these operations are Voith Sulzer Paper Technology, one of the largest suppliers and service providers to the pulp and paper industry on this continent. Continuing growth in North America will see an addition of a 41,000 sq. ft. manufacturing area along with a 14,000 sq. ft. office space in Appleton, and a 15,500 sq. ft. additional expansion in Middletown, Ohio.

"We've come to where we are today because of our past ... and our past is the key to our future," said Werner Kade, President of Voith Sulzer Paper Technology North America, Inc. According to Kade, "Our future will continue our tradition of drawing on the vast North American resources and talent, in a spirit of cooperation with our European partners, to deliver the greatest benefits to our customers."

10

11

# NEWSPAPER HOAXES

The ingenuity of journalists





On November 9, 1874 the owner of the New York Times ran out into the street, heavily armed, and stalked his way carefully through the city, overcome by fear and terror, in order to complain at the local police station about a severe lack of information. He had just read an article in the rival newspaper *The Herald*, which to his horror reported the escape of a whole series of wild animals, including extremely dangerous big cats, from Central Park Zoo. Witnesses claimed to have seen these animals attack and kill at least 27 people, and a list of these unfortunates was printed. About 200 injuries were reported, with some of the victims horribly mutilated. Most of the wild animals were still on the rampage in the Fifth Avenue area, with only 59 of them so far recaptured or shot at the time of the *Herald* going to press. The danger to the populace at large was not yet over.

A story line which could just as easily come from the Jurassic Park film – and indeed the story was just as fictional! The owner of *The Times*, who really should have known better, was completely taken in by the story. Fear and terror had made him forget the journalist's unwritten law: read the story exactly and read it to the end. Like many of his contemporaries, he also failed to read the last sentence, which stated: "The entire story given above is pure fabrication. Not one word of it is true." In other words, it was deliberately intended to mislead uncritical readers, an ingenious ploy thought up by the journalist with the laudable aim of drawing attention to the safety risks at the New York zoo. This type of nonsense is quite far removed from the vision Johannes Gutenberg had when he revolu-

tionised the printing process with his interchangeable metal type. "Truth", he no doubt thought approximately 450 years ago, "yes, truth will now reach out into the last corners of the world." One of Gutenberg's first printed works was the Bible. The official Truth was now available to everyone, the Word of God could now be read without having to rely on interpretations from the clergy. One looked reverently upon the printed book and placed one's faith in the written word. Those black letters pressed onto white paper with the entire weight of heavy metal had begun their advance.

This sacred trust was quickly shattered by cunning counterfeiters and their resourceful counterparts, the authors. These sharp-witted minds caught on immediately to the fact that paper in its naive innocence will accept anything that the printing press delivers. Some choose to create new worlds, others took to writing documents, reports and news articles in order to control worldly things. "Maneggiare la realtà" – in English: to touch upon reality, or in more modern terms: to manage the world – was in Machiavelli's time quite common, a period in which some of the most famous counterfeiters carried out their trade under the cloak of secrecy. They bore false witness and let the black letters on the printing block proclaim it to be the truth.

The belief in "black ink on white paper" was finally shattered with the onset of newspapers, which took to the world's stage in the 17th century in the form of pure "news sheets". Widespread distribution of these printed articles increased the power of the men-of-action, en-

hanced undoubtedly by a faith in authors who declared their intention of writing down in the new medium nothing more nor less than that which actually occurred in the world. "The Public Newspaper" appeared to upright thinkers to be the "organ which preaches to the people and the voice of truth which penetrates not only the palaces of the mighty, but also the huts of the lowest." Someone who believed in this within the finest meaning of enlightenment was the German writer Karl Philipp Moritz, who in 1784 was editor of the "Vossische Zeitung".

But with the newspaper was born an unpleasant twin, a tiny Beelzebub: the newspaper hoax, known in Germany and France as "die Ente"/"le canard" (duck) respectively. The hoax – a cunning bird – is full of deceit and constantly changes its form. It creeps across the white paper (which nowadays quite often has a grey tinge) as a full-scale deception, or surfaces as a confident lie in the garb of a politician. Sometimes it appears in a respectable disguise, sometimes it's loud and vociferous, sometimes it emerges from the mouth or pen of an author's foolish henchman. For uncritical professionals and readers, the hoax is usually difficult to detect. Excellent bloodhounds are needed, who with inborn criminological instinct can hunt down and expose even the most elegant of yarns.

Karl Philipp Moritz had only to turn his attention to Prussian Berlin to see that his vision of the newspaper was already being questioned. An extremely honourable nobleman, the renowned Prussian King Friedrich the Great, a few centuries earlier, had had his fun and games

with his contemporaries' faith in the newspaper. He personally set one or two hoaxes in motion, just to see which dizzy heights of persuasion they would finally reach on their journey through the Berlin newspapers of the day. One of his misdeeds has been handed down to us, namely from March 5, 1767. He placed a report in the paper stating that roughly one week previously, a devastating hail-storm had raged over Potsdam – a strategic hoax with the aim of providing the population with a topic of discussion that would take the place of the forthcoming military campaign which up till then had been on everyone's tongues.



The newspaper's ambition to provide people with detailed facts so that they could comprehend the machinations of the world better and by doing so finally master superstition, actually succeeded in calling a new form of gullibility into being. It can be briefly described in this way: the newspapers state what is going on in the world. Therefore, what is printed there – in black and white – must ac-

tually have happened. The grey sheets soon became the Bible for the enlightened professions. Berlin's newspaper readers, and similarly the readers of the *New York Herald*, firmly believed the printed reports of catastrophes, an obviously rock-solid dogma on which politicians and even the "Yellow Press" in our so-modern century can continue to rely.

Even today, honourable institutes use the newspaper to stage their foolish pranks. April 1st has become the ideal day in the Western world to make fun of the readers in a non-punishable manner and to draw attention to oneself by means of sophisticated but harmless hoaxes. In 1986, the British Energy Ministry placed full-page advertisements in the London-based daily newspapers *The Times* and *Guardian* in order to play a fully-fledged governmental hoax. Disguised as a "Government Announcement" and filled with diagrams and details of powerful scientific credibility, it announced to the British population that they should put on their T-shirts at 11:00 Central European Time, due to the fact that a shift in the Earth's axis would move the British Isles extremely close to the equator. The same day's edition of *The Times* contained an advertisement supported with relevant diagrams by the German car manufacturer BMW, which promised British car owners a rosy future when driving on the European continent: apparently the steering wheel could be mounted on the right-hand side of the car by performing just one or two simple operations. BMW: the first car with left- and right-hand drive. Two hoaxes with jester's caps on, although it has to be said that they were not only highly inventive but also honourable, since they re-

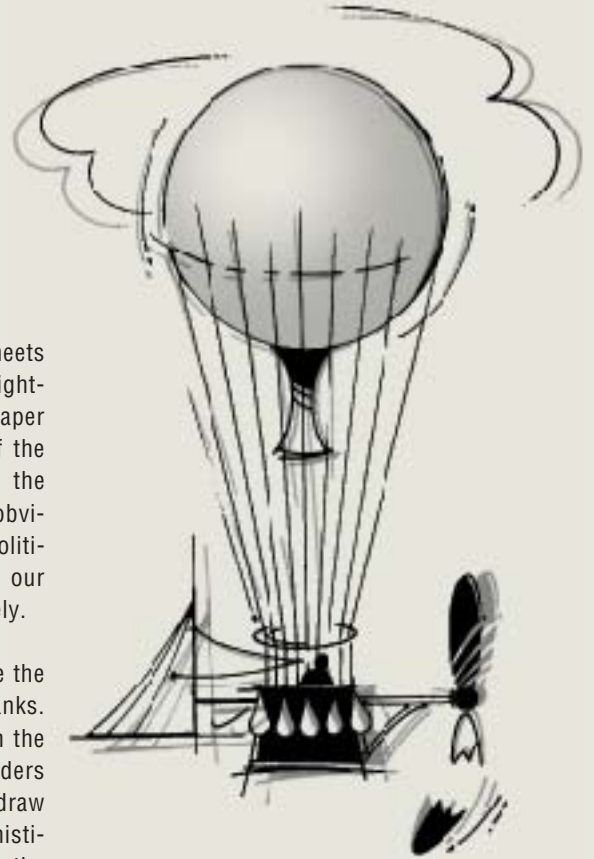

vealed their true identity at the end of the advertisement.

Hoaxes such as these were very common in the 19th century in the columns of the booming newspaper industry. Newspapers were springing up everywhere and were soon desperate for circulation, so they had to be filled with interesting stories. The hunt for sensation was up and running; the race against the competition was on. All these contenders for readership attempted to buy in the best news articles and stories – some of which unfortunately were not verified before being printed, due to the keen rivalry between newspapers to be first. Among those who assisted in producing exciting copy were famous minds such as Mark Twain, who wrote for the *Virginia City Territorial Enterprise*, or Edgar Allen Poe, who earned his money working for various "dailies". Poe, that master of the perfectly constructed horror and criminal story, announced on April 13, 1844 in the *New York Sun* that a captive balloon, albeit

unintentionally, had crossed the Atlantic from Europe. Equipped with a propeller, it had been on the way from London to Paris with the famous Monck Mason on board. Unfortunately, the propeller had broken down and the aeronautical vehicle was no longer controllable. After 76 hours, believe it or not, it landed in Charleston, South Carolina, driven all the way by an easterly wind. Of course, not a word of it was true! But people asked themselves if a science-fiction hoax which fitted ideally into the progressive thinking of the century, could not perhaps be justified in a world where so many fantastic things were indeed possible.

It was all quite harmless really: the entire collection of foolish hoaxes had no permanent or tangible after-effects for the people who had fallen for them. However, a joke can indeed have a lasting effect, and a simple newspaper article can sometimes turn into a document with dramatic consequences. In Chicago in 1899, a group of reporters, each one employed at one of the four local daily newspapers, came up jointly with what they thought was a brilliant idea. They all filed a report stating that the Chinese had decided to tear down the 2,450 kilometre-long Chinese Wall. The planning and execution of this gigantic project had been placed in the hands of American engineers, who at that very moment just happened to be staying in Chicago. This turned out to be a newspaper hoax with diplomatic consequences, a hoax which became entangled in the network of American-Chinese relations. The Asians suspected an act of United States aggression, and it was even suggested in various quarters that the hoax had con-

tributed in a small way to the Boxer Rising (though this was never corroborated.)

In spite of all this, the hoax just described is well on its way to exchanging its jester's cap for a spiked helmet. This war helmet was most definitely a feature of the so-called Emser Depesche. The German "Reichskanzler", Otto von Bismarck, received a telegram in 1870 in which His Majesty the King reported on talks conducted between himself and the French Ambassador. The King also mentioned that it was no longer necessary to receive the ambassador any more as they had discussed the matter at hand fully. Bismarck abbreviated the text ingeniously. His version then gave the impression that the King no longer wanted to receive the Ambassador. The wily statesman had taken the relevant words out of context and allowed them to appear as a categorical rebuke. He passed his version on to the press and got his sought-after war with France, which he needed urgently to

unite the German states under Prussian rule. His manipulation of this information went into the history books as a monumental piece of written "reality management". Today, this type of information manipulation is quite common. We no longer refer to these "half-hoaxes" which are usually to be found in the political arena, as lies, but as public relations or advertising.

So newspapers do indeed tell lies; it's all there to see in black and white, and the innocent paper to which we are all too prone to allocate the role of the accomplice is crushed by the mendacious type fonts. Information and news reports don't describe the world as it is, but could be said to reinvent it. And there are prizes awarded these days for doing so, as the example of the reporter Janet Cooke will illustrate. An article which appeared in the Washington Post on September 28, 1980 claimed to relate the horrendous story of a boy who was already addicted



"twogether" is published twice annually in German and English. Contributions by independent authors do not necessarily reflect the opinion of the publisher. Please address all correspondence and inquiries to the editor.

Published by:  
Voith Sulzer Papiertechnik GmbH & Co. KG

Editor:  
Dr. Wolfgang Möhle, Corporate Marketing,  
Voith Sulzer Papiertechnik GmbH & Co. KG,  
P.O. Box 1970, D-89509 Heidenheim  
Tel. (++49) 73 21 37 64 05  
Fax (++49) 73 21 37 70 08

Editorial coordinator:  
Manfred Schindler, D-73434 Aalen

Design, layout and typesetting:  
MSW, P.O. Box 1243, D-73402 Aalen

Copyright 7/97:  
No part of this publication may be reproduced or copied by any means whatsoever without the express permission of the editor.

# twogether

Paper Technology Journal

Newsmagazine for the international clientele, partners and friends of

**VOITH SULZER**  
PAPER TECHNOLOGY



to heroin at the tender age of eight. For this, she received the Pulitzer Prize. True, she only bathed in the glory of this award for a short time, until the mask of deception was finally torn away. Her report turned out to be a clever and brilliantly written hoax – pure fabrication.

Reporters and journalists are equal in every way to those who write works of fiction. But time and time again, to our great good fortune, it is their very own colleagues who put a stop to this misguided creativity. A weekly magazine published in France is particularly uncompromising in its treatment of hoaxers. The satirical publication known as *Le Canard enchaîné*, whose only purpose in life is to put "hoaxers" in chains (*enchaîné*). The magazine tends to hunt mainly over others' estates, despatching its henchmen to flush out the hoaxes in other newspapers and media. Quite a few politicians have

already tripped up over their own hoaxes, which the uncompromising hunters have gathered in and given a prominent place in their publication, causing the victims' careers to falter.

Thus is the honour of the newspaper publisher re-established. Veracious, upright journalists do everything they can to ensure that their pages are kept free from the work of the crafty hoaxer and to protect the readers from the consequences of a hoax actually making it into print. In the case of our zoo story at the beginning, the originators of the story were fully aware of their responsibilities. Not only was the article intentionally written as a hoax and declared as such in the paper, but the *Herald* editor took action immediately after seeing the chaos on the streets of New York, and put a stop to any further distribution of that particular issue.

*We owe the entertaining review of newspaper hoaxes to Dr. phil. Hans-Joachim Grautner, author, free-lance journalist and essay writer in the arts, culture, literature and radio drama areas, who is also a contributor to the Stuttgartar Zeitunger newspaper.*

#### Correction:

Although we cannot claim this as a "news-paper hoax" – our customer journal twogether is not entirely immune to the misprint gremlin. Unfortunately, in the last issue, No. 3, two errors have crept into the text. The article "GR cover – next generation performance leader" should read as follows on page 53: "Since the cover has a minimum thickness limit .010", there is ample material for multiple regrinds."

In addition to this, some of our customers received a German copy instead of an English one or vice versa. All those who contacted us in this connection were subsequently supplied with the "correct" language. Please let us know if there were any more cases of confusion. We will naturally supply a copy in the required language.