

# Pumped storage machines

Reversible pump turbines, Ternary sets and Motor-generators

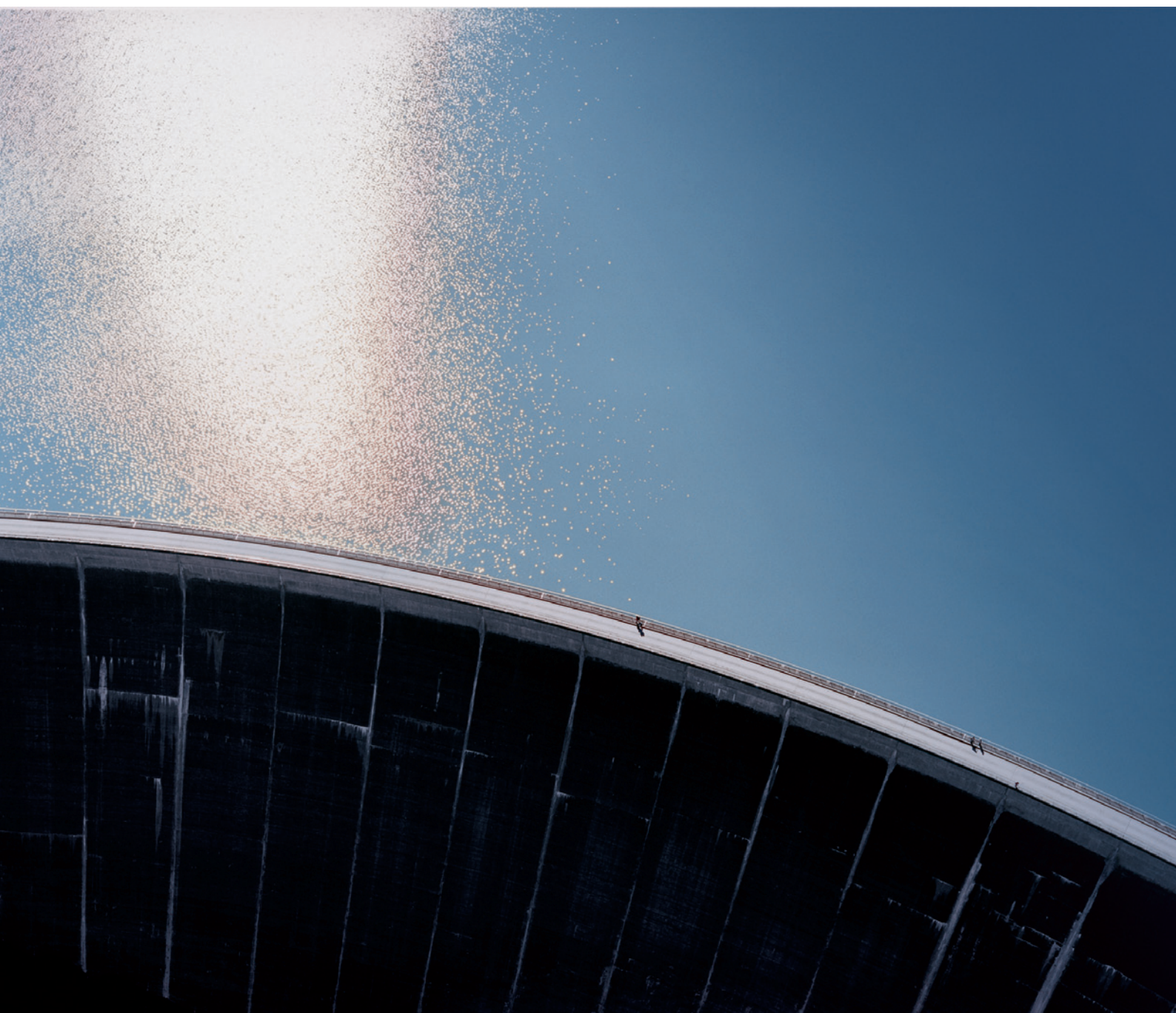



Cover picture Limberg II, Austria

- 1 Hongrin Lemon, Switzerland
- 2 Upper reservoir Latschau, Rodund II, Austria
- 3 Rodund II, Austria

# Harnessing the power of water with engineered reliability

Generating energy from the power of water represents large amounts of clean, renewable energy. 71 percent of the earth's surface is covered by water. The world's hydropower potential amounts to 20 billion Mega Watt hours per year and only 25 percent of this has been developed so far.

Hydropower is not only environmentally friendly, but also cost-effective. Hydropower plants have the highest operating efficiency of all renewable generation systems. They are largely automated, and operating costs are relatively low. Hydroelectric power plants also play an important role in water resource management, flood control, navigation, irrigation and in creating recreation areas. Voith is a leading enterprise manufac-

turing generators, turbines and associated control systems. As one of the world's leading provider for hydropower products and services, Voith has an amazing portfolio: We offer a wide range of services, such as engineering, manufacturing, project management and commissioning.

As part of our international network each Voith facility is equipped with consistent best-in-class processes and tools. This network also ensures that we can meet special customized requirements: from individual components to project planning, through project management and plant maintenance. With branches and production facilities for electrical and hydraulic machines and components in Europe, Asia, North and South America we are close to our cus-

tomers and active in all major hydropower markets worldwide.

With more than 140 years' experience in the field of hydropower and high annual spending for research and development, Voith is well-equipped to continue delivering excellence in hydropower in the years to come.

## Engineered reliability

Is our promise to our customers. Our products and services are designed specifically for our customers' needs. Moreover, we follow our values and visions for sustainable hydropower solutions with no compromise.

## Competences and capabilities

- Consulting, engineering, erection and commissioning
- System and plant assessments
- HyService – global, fast and effective for modernization and rehabilitation of existing hydroelectric power plants
- Complete equipment, installation and services for hydroelectric power plants
- Francis, Pelton, Kaplan, Bulb/Pit/S-turbines, pump-turbines, standard and customized products
- Storage pumps, radial, semi-axial and axial-flow pumps
- Torque converters
- Generators and motor-generators for constant and adjustable speed, excitation systems

- Frequency converters, protection systems, switchyards for all voltages, transformers
- Power plant automation, control centers for hydropower plants and cascades, including plant management and diagnostic systems
- Shut-off valves
- Integrated Management System to safeguard excellence and quality

# Voith's pump storage plants work from the start

Clean, flexible and renewable: Pumpstorage power plants offer a highly reliable technology which can perfectly level grid fluctuations and deliver energy immediately. In a world of energy increasingly dominated by wind and solar, pumpstorage power plants are indispensable. Over a period of decades Voith has developed a cutting-edge technology.

In 1937, Voith developed the first large pump-turbine, which operated both as a turbine for energy generation and, in the reverse direction, as a pump.

The first pumped storage station in Germany was installed in 1908 in the Voith research and development building, the Brunnenmühle in Heidenheim, Germany.

To meet the demanding requirements of a pumped storage plant, Voith applies a distinctive quality management. Each component is manufactured with the highest technical standard, i.e. shut-off valves, torque converters or clutches. With regard to the plant's arrangement, Voith always find technical solutions which improve the readiness for operation and a rapid transition from turbinning to pumping, and vice versa.

In supplying equipment for pumped-storage plants, Voith gained a lot of experience in hydraulics over many years. A very large number of versatile Voith designs have proven extremely satisfactory in practical operation. In some cases this experience covers many decades. It makes no difference whether demand is for a reversible pump-turbine or an optimally designed turbine and pump. Nor is it of importance whether the pumpturbine is equipped with a fixed or an adjustable distributor or whether, in the case of separate turbine and pump, a clutch operable at standstill, a starting turbine or a synchronising

torque converter permitting extremely short changeover times is to be provided.

Today, more than 200 Voith pumped storage units have been installed worldwide with a combined output of well over 24 000 MW. Whether a reversible pump-turbine, or a turbine and a pump combination, these machines have proven to be extremely durable, in many cases they have performed reliably for several decades.

1+2 Limberg II, Austria

3 Waldeck 3D model, Germany

Cross section of a Pump turbine/ Generator unit

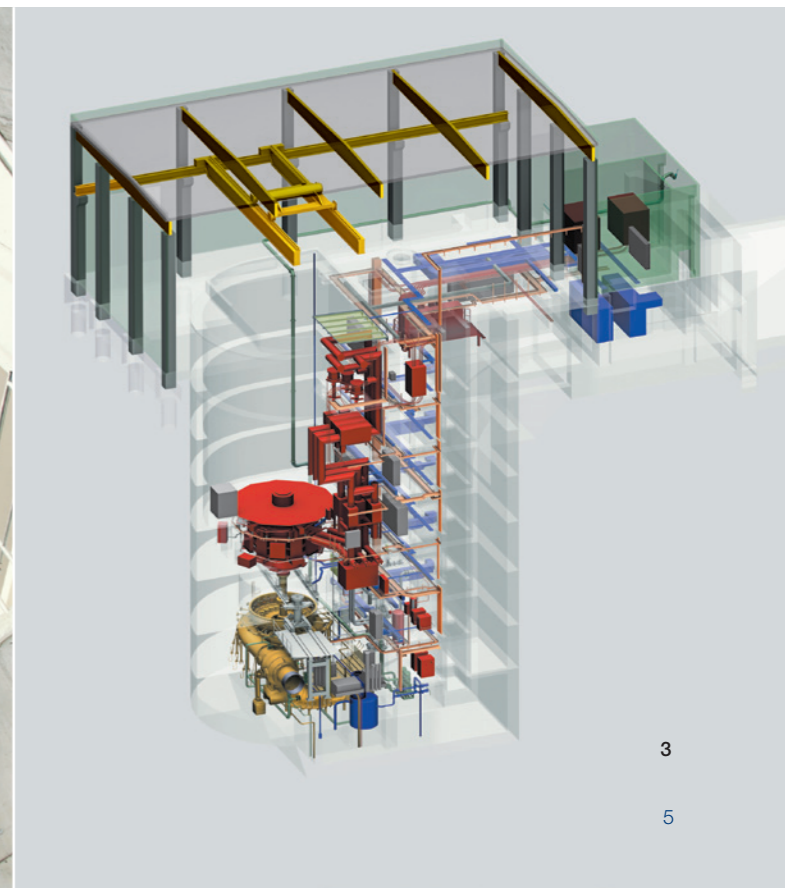
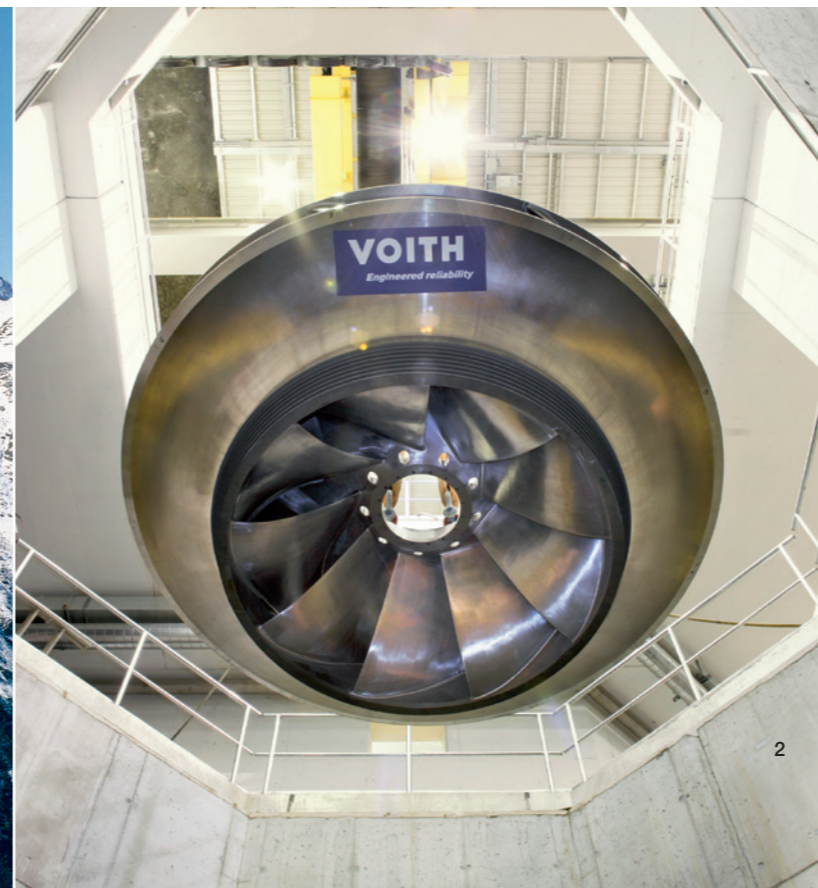
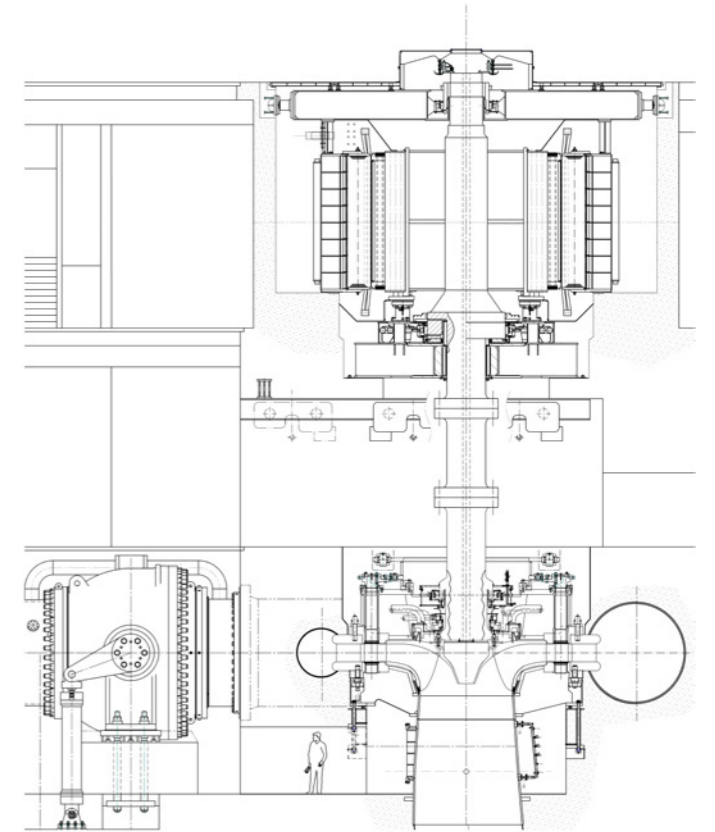

# Characteristics of reversible pump-turbines

Advances in technology are constant, including the latest developments on variable-speed and wide head range applications.

Reversible machine sets consist of a motor-generator and a reversible pump-turbine that works either as a pump or as a turbine depending on the direction of rotation. Furthermore, a well-designed, compact power house save equipment and civil costs. With a wide range of specific speeds, pump-turbines can be installed at sites with heads from less than 50 to more than 800 m, and with unit capacities ranging from less than 10 to over 500 MW.

## Variable-speed

With the use of variable speed technology, by use of asynchronous motor-generator or synchronous motor-generator with frequency converter, the rotational speed of the pump-turbine can be varied. Thus, the turbine operating range can be extended, the pump capacity can be adjusted to using just the currently available amount of energy. This technology stabilize the grid efficiently.

- 3 Lewiston
- 7 Coo I
- 12 Raccoon
- 14 Rodund II
- 21 Bath County
- 22 Coo II
- 24 Estangento
- 25 Gabriel y Galan
- 27 Kühtai
- 29 Obrovac
- 31 Presenzano
- 34 Palmiet
- 35 Bad Creek
- 36 La Muela
- 37 Herdecke
- 38 Chiotas (4 stage)
- 39 Mingtan
- 42 Shisanling
- 43 Guangzhou II
- 44 Edolo (5 stage)
- 45 Goldisthal  
(two variable speed)
- 47 Venda Nova
- 48 Tai An
- 49 Siah Bishe
- 50 Waldeck I
- 51 Limberg II
- 52 La Muela II
- 53 Ingula

Selected pump-turbines: operation range in pump mode

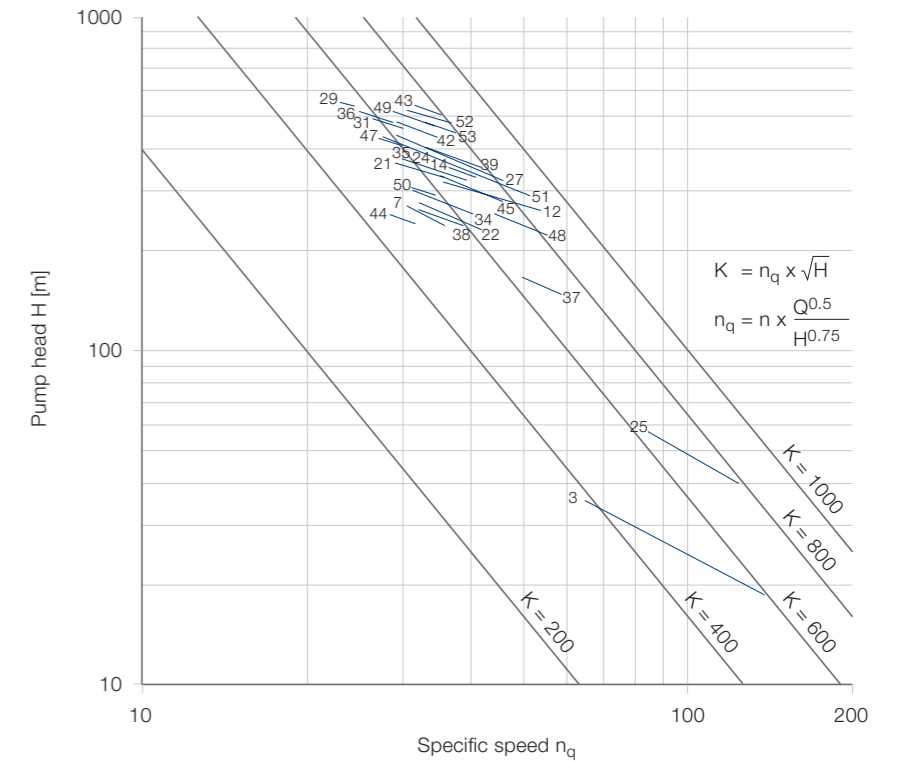

- 1 Goldisthal, Germany
- 2 Limberg II, Austria

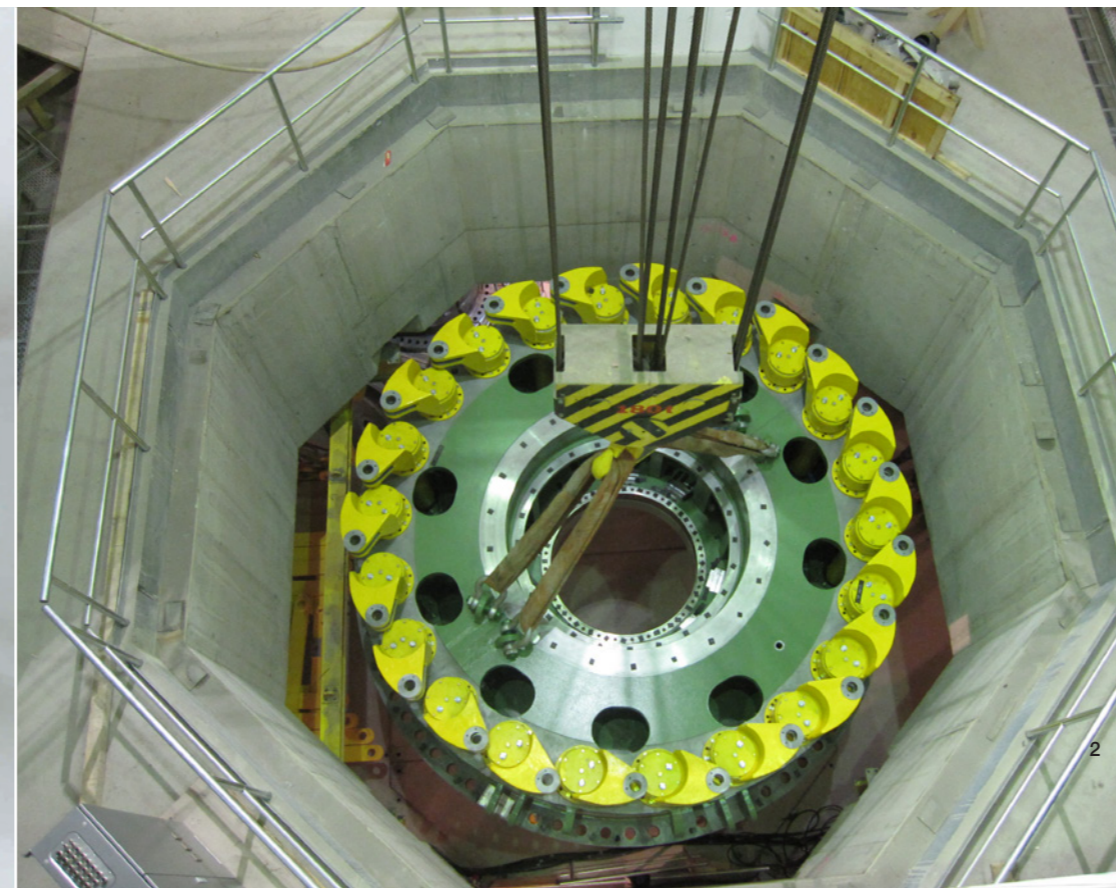
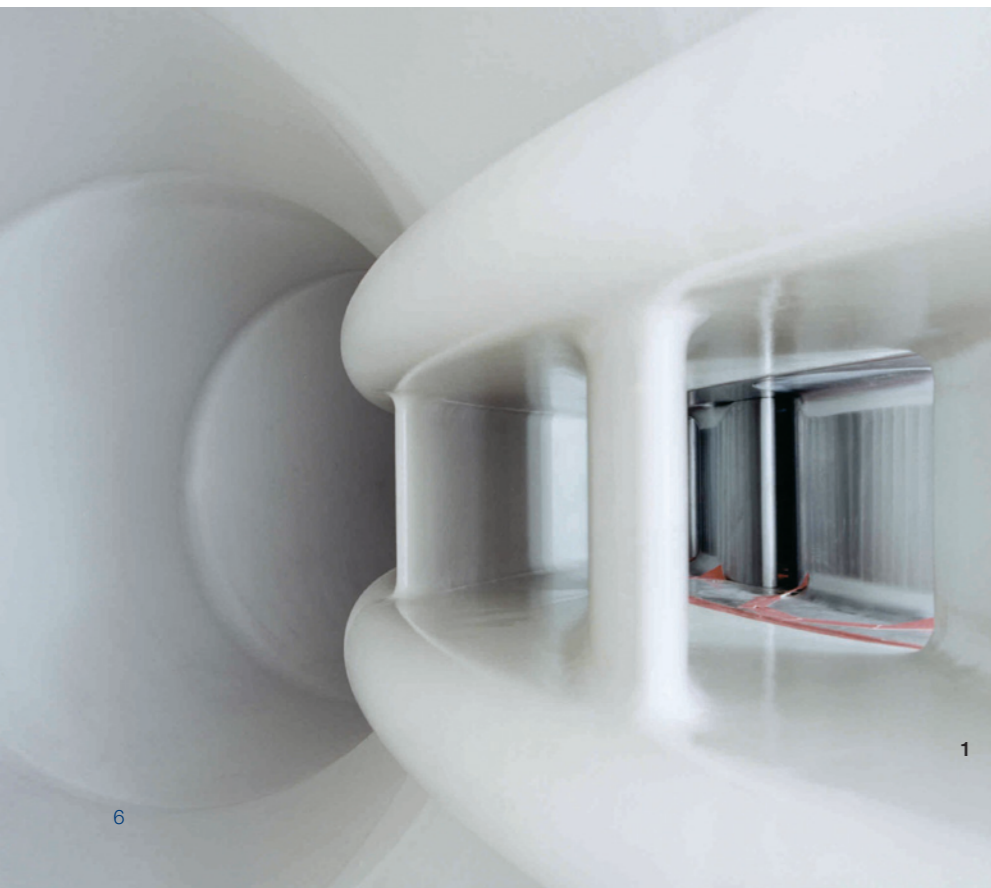

Application range

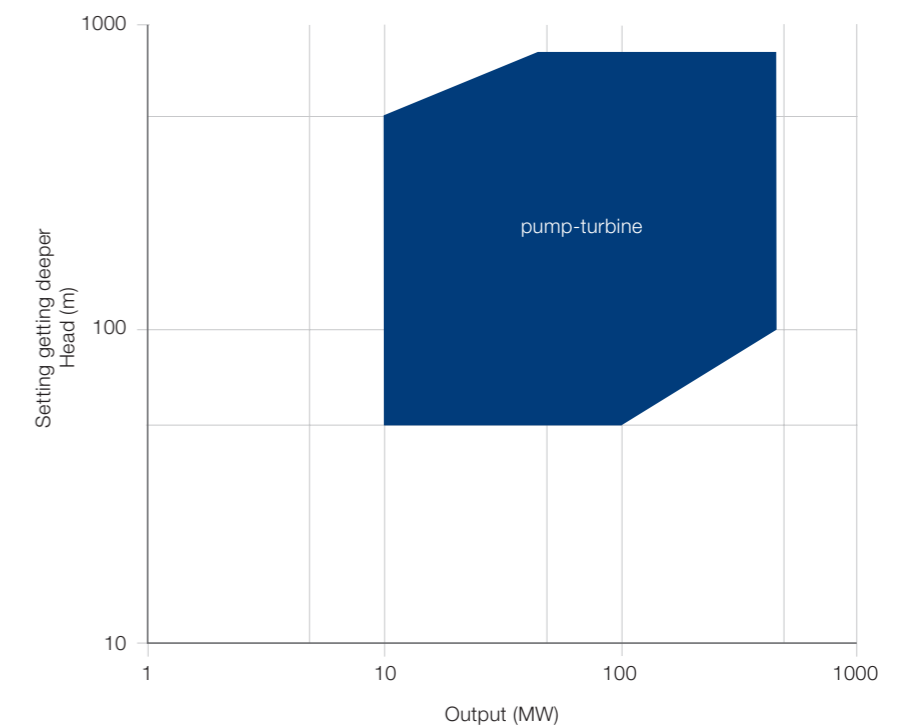

# Characteristics of storage pumps and torque converter

Worldwide, Voith has earned a reputation as a major pump manufacture. Many pump storage plants work smoothly with Voith equipment. It's the efficiency and longevity that matters when running pump storage plants. Our strength: reliable customized solutions.

Pumps for storage applications are mainly of the radial-flow type.

Depending on the application conditions the construction, can be a single- or double-flow, single- and multi-stages

### Torque converter

The torque converter provides the most time efficient startup and shutdown of a storage pump. Within seconds the storage pump can be connected or separated from the shaft system.

It transmits torque and/or power from the motor-generator to the pump shaft by being filled with process water.

Start-up of the storage pump begins already during the filling process. As the pressure level of the filling water rises, the torque output by the converter increases and thus accelerates the pump.

This acceleration torque, which is initially very high, continuously decreases as secondary speed rises. When reaching the synchronous speed, the converter output torque corresponds to the pump priming torque.

Due to the soft interaction of these processes, the storage pump can be started up quickly. No load surges for the grid occur.

### Hydraulic Torque Converter

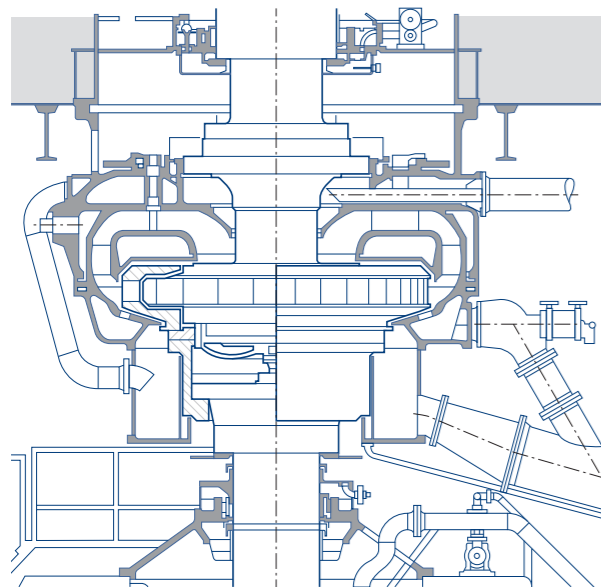

### Application Range Radial-flow pumps

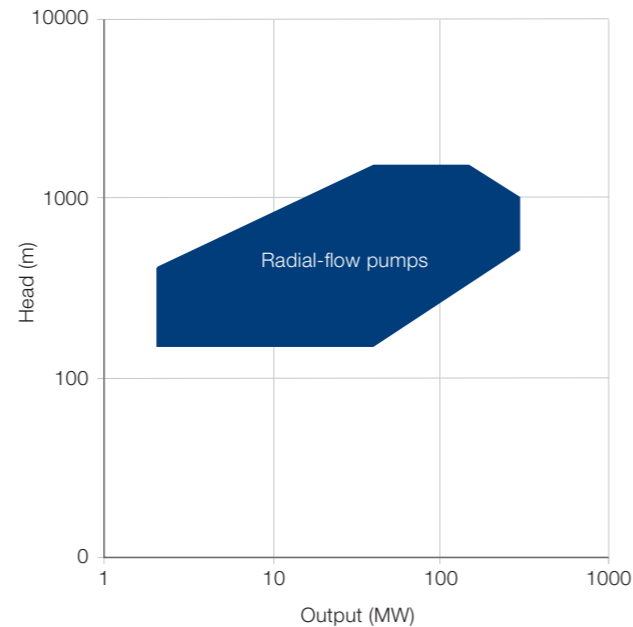

### Storage Pump, 3D model

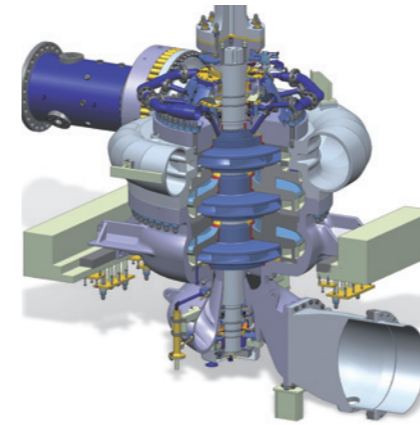

### Ternary sets

Ternary sets consist of a motor-generator, a separate turbine (typically Francis or Pelton) and a pump set. As two separate hydraulic machines, the rotational direction of the motor-generator can be the same in both operational modes. This results in considerable commercial value for the power plant's operation. For switching between turbine and pump operation, the following components can be provided: a clutch operable at standstill, a starting turbine or a synchronizing torque converter. With the configuration of a ternary set the, so-called hydraulic short circuit within the machine set can be implemented. It offers the best answer for a very fast grid response, being carried out with the torque converter which allows fast change over between turbine and pump mode. Full regulating capability exists in both, the turbine and the pump mode operation from 0% to 100% of the unit output.

### Hydraulic short circuit

By using the hydraulic short circuit concept almost the full power range of the plant is available. Moreover, this application helps to control the energy flow into the grid. The principle of this operation mode is based on the idea that only the difference between the constant pump load and the flexible turbine output, both rotating on one common shaft, should come to the grid.

### Ternary set

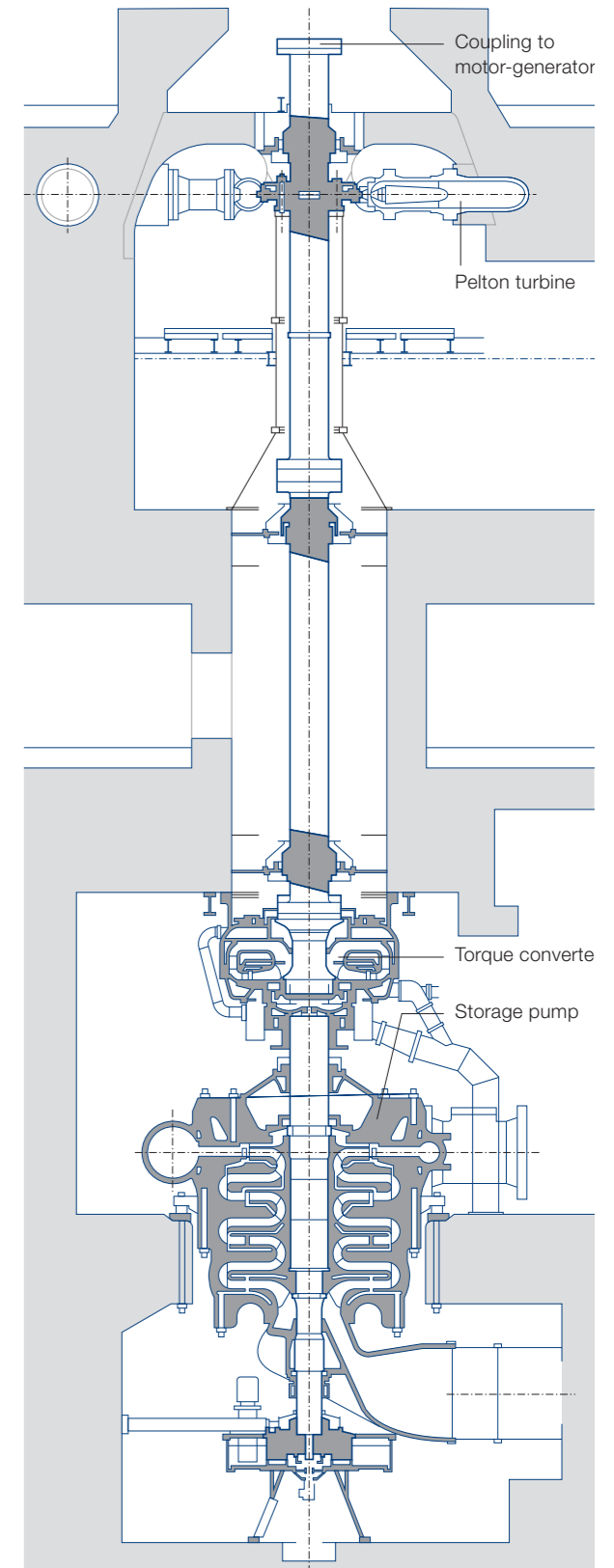

# Motor-generator characteristics

Since the early beginning of manufacturing hydropower plants, Voith has supplied the world's largest and most powerful units in performance and size at their time. Voith always managed to go beyond limits.

Power demand increases with a growing economy and the improvement of living standards. Following this trend, the capacity of power supply units has increased continuously. From the early 20th century, Voith has manufactured outstanding motor-generators, for instance.

The world's most powerful motor-generators for Bath County (USA), delivered in 1976.

Or take the high-speed motor generators installed at Guangzhou II in China in 2000. These are among the largest of its kind.

## Our technology sets us apart

- Motor-generator technology – including excitation, static frequency converters (SFC) and SCADA systems.
- Well-advanced and proven VPI insulation system for optimized design for Class 155 according IEC (formerly Class F) and voltages up to 27 kV.
- Motor-generators are air-cooled by RIM-Ventilation, forced ventilated or direct water-cooling of stator or stator and rotor windings and also stator core.
- Magnetic thrust bearings for reduced torque during pump starts and reduced bearing losses during normal operation.
- Comprehensive system for the entire automation including monitoring. Furthermore, Voith offers remote supervisory control and data acquisition of the plant with fiber optic cable for control and station networks.
- Static frequency converter systems composed of computer duplex digital controller. Moreover, we supply and optical thyristor of high resistance voltage for a highend performance and easy maintenance.



## The following design criteria influence the generator's main dimensions:

- The specified output can be produced by the dimensions within the allowable limit of temperature rise of windings and stator core.
- The required moment of inertia must be provided within the given stator bore dimensions.
- The mechanical stress incurred by the rotating parts at runaway speed can be handled within the maximum allowable stresses of the specific material.

- A safe margin is provided between the first critical speed and the unit's runaway speed. Shorter lengths and lighter rotor weights help to determine this margin.
- In case of air-cooling, a shorter core length and a larger diameter are better for uniform cooling along the entire core length.

To achieve optimum economics, larger unit capacity machines are often being designed in order to reduce the number of units at each plant. In addition, high-speed rating is another important factor for smaller volume machines.

Direct water-cooling is a very effective method in compact machines. Voith has vast references in both air-cooled and water-cooled machines as shown below.

## History of generators and motor-generators

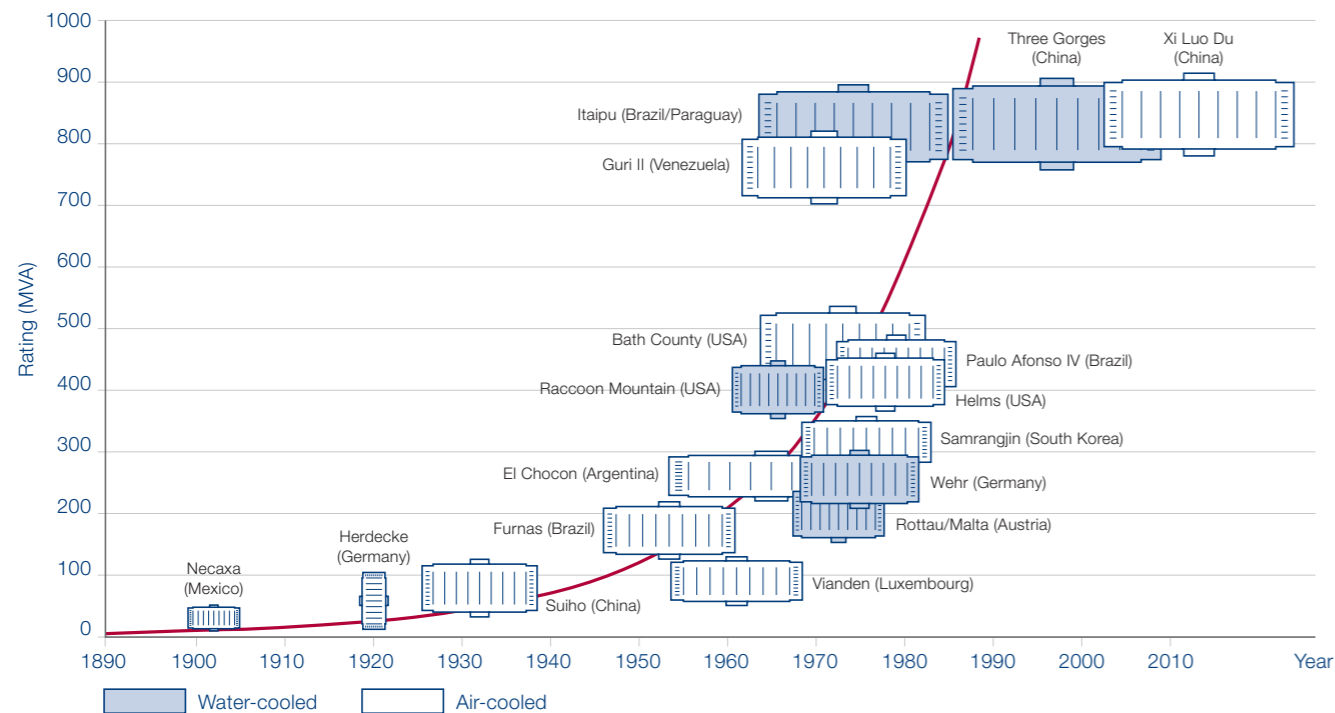

## Generators and motor-generators

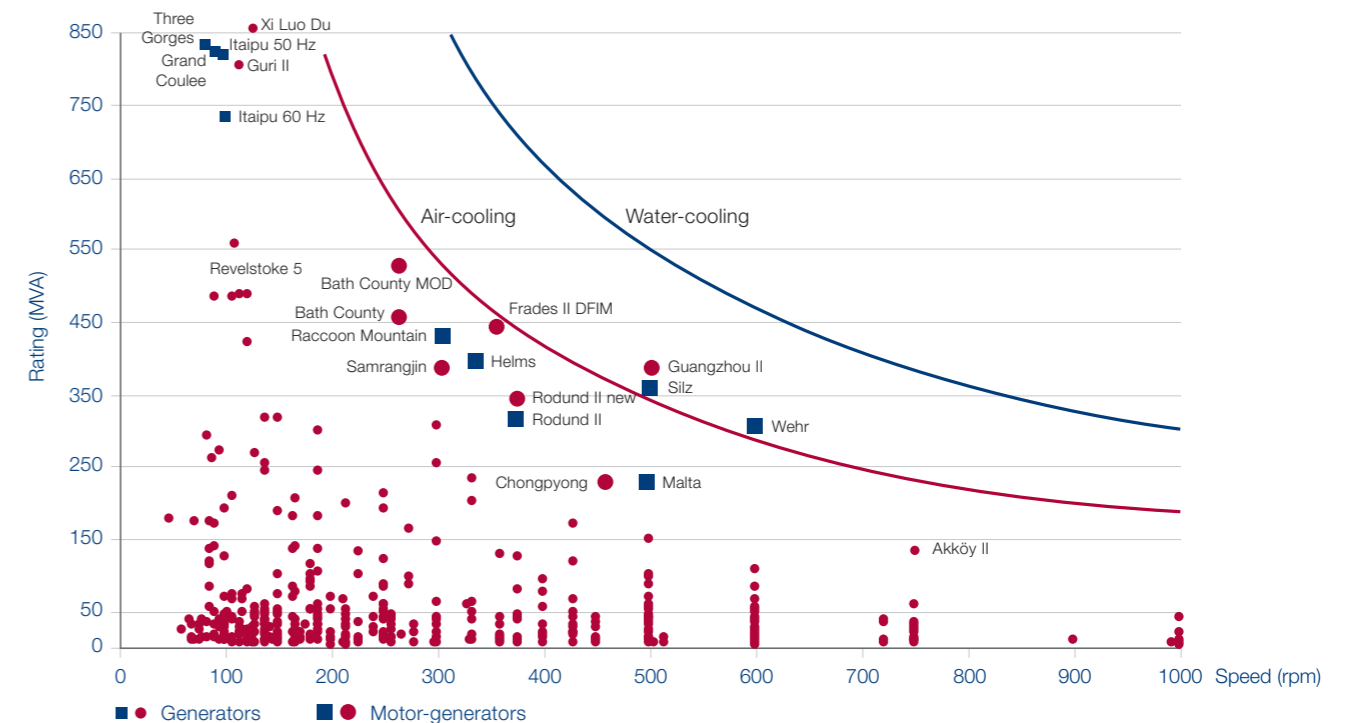

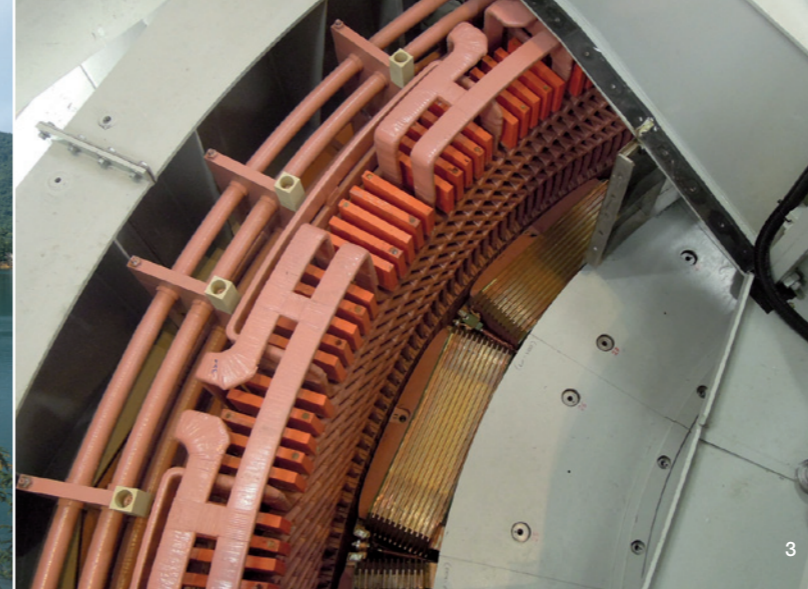

1 Goldisthal, Germany  
 2 Guangzhou, China  
 3 + 4 Rodund II, Austria

### Reversible pump-turbines and motor-generators

- 1908** First pumped storage plant in Germany in Voith's hydraulic research laboratory, Brunnenmühle, Heidenheim.
- 1937** Pedreira, Brazil: First reversible pump-turbine in the world with an output of 5.3 MW, 30 m, 212 rpm.
- 1964** Roenkhausen, Germany: First reversible motor-generator unit in a German pumped storage plant.
- 1966** Coo-Trois Ponts 1, Belgium: Three 145 MW, 270 m, 300 rpm pump-turbines and motor-generators. First reversible pump-turbines in Belgium.
- 1970** Raccoon Mountain, USA: Highest capacity pumped storage plant in the world at that time, with four 392 MW/425 MVA, 300 rpm pump-turbines and motor-generators and with directly water-cooled stator and rotor.
- 1970** Vianden 10, Luxembourg: One 230 MVA, 333,3 rpm motor-generator.
- 1971** Wehr, Germany: Worldwide highest synchronous speed for large motor-generators with four 300 MVA motor-generators and with directly water-cooled stator and rotor at 600 rpm.

- 1974** Rio Grande, Argentina: Four 187.5 MW, 178 m, 250 rpm, pump-turbines, inlet valves and 210 MVA motor-generators. First reversible pump-turbines in Argentina.
- 1974** Chiotas, Italy: Two 4 storage 105 MW reversible pump-turbines with a head of 1047 m.
- 1976** Bath County, USA: The world's most powerful pump-turbines and motor-generators at that time, six units with an output of 458 MW/447 MVA, 329 m, 257 rpm.
- 1977** Helms, USA: Three motor-generators rated at 343.2 MW/390 MVA, 360 rpm with directly water-cooled stator.
- 1977** Odolo, Italy: Six 5 storage reversible 130 MW pump-turbines with a head of 1256 m.
- 1981** Samrangjin, South Korea: Two 385 MVA, 300 rpm motor-generators. The highest capacity reversible units in Korea.
- 1983** Palmiet, South Africa: Two 253 MW/250 MVA, 301 m, 300 rpm pump-turbines and motor-generators.
- 1992** Shisanling, China: Four 204 MW, 430 m, 500 rpm pump-turbines and inlet valves, providing reliable peaking power for China's capital.

- 1994** Guangzhou II, China: Four 306 MW/380 MVA, 510 m, 500 rpm pump-turbines and motor-generators in the world's largest pumped storage plant with a total output of 2,400 MW.
- 1997** Ghatghar, India: Two 139 MW, 445 m, 500 rpm, pump-turbines and motor-generators, enhancing the quality of India's electric energy supply.
- 1997** Goldisthal, Germany: Two 270 MW, 307 m, 333 rpm pump-turbines for the most recent German pumped storage plant including variable-speed technology (300-346,6 rpm).
- 2000** Venda Nova II, Portugal: Two 106 MVA, 600 rpm motor-generators and two 92.5 MV pump-turbines.
- 2001** Bath County, USA: Refurbishment of stator windings and installation of new runners push these units to once again become the world's highest output pump-turbines and motor-generators at 480 MW/530 MVA.
- 2002** Tai An, China: Four 278 MVA, 300 rpm motor-generators and four 250 MV pump-turbines.
- 2004** Siah Bishe, Iran: Four 300 MVA, 500 rpm motor-generators and four 260 MV reversible pump-turbines.

- 2006** Limberg II, Austria: Two 240 MW pump-turbines with optimum design to meet wide head range application.
- 2007** La Muela II, Spain: Four reversible 213 MW, 600 rpm pump-turbines and spherical valves, max. pump head 531 m, to deliver reliable power to the grid.
- 2008** Ingula, South Africa: Supply of complete electro-mechanical equipment with four 342 MW/373 MVA, 428,6 rpm pump-turbines and motor-generators.
- 2010** Rodund II, Austria: One 295 MW, 375 rpm vertical reversible pump-turbine and 345 MVA motor-generator.
- 2010** Reisseck, Austria: Two 215 MW, 580 m vertical reversible pump-turbines.
- 2010** Frades II, Portugal: Two reversible 372 MW pump-turbines and Europe largest and powerful variable speed motor-generators (DFIM) with 433 MVA and speed range 350 up to 381 rpm.
- 2010** Hong Ping, China: Four reversible 306 MW pump-turbines and 333 MVA, 500 rpm motor-generators.

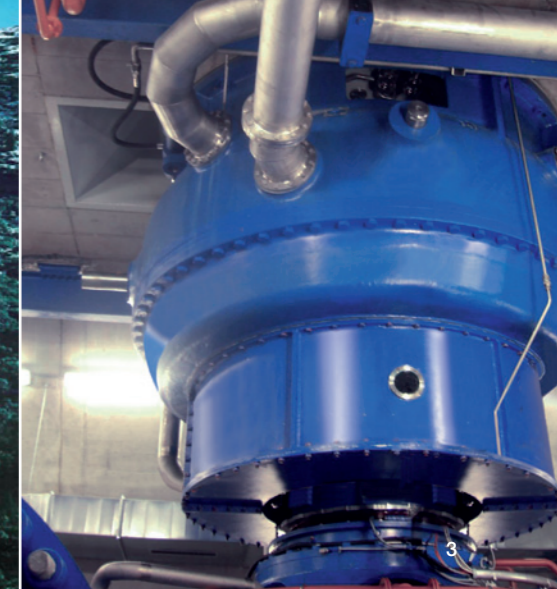
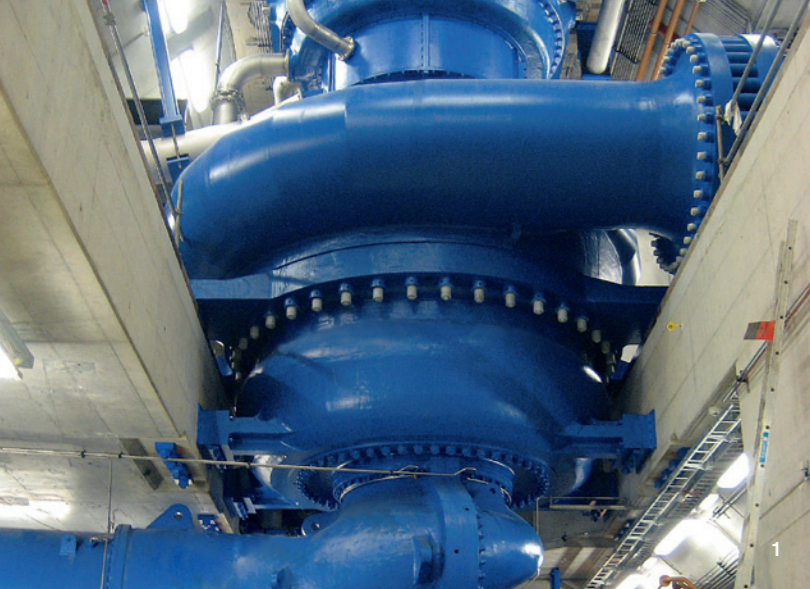

1 Storage pump, Kops II, Austria  
 2 Kops II, Austria  
 3 Torque converter, Kops II, Austria

### Storage Pumps

- 1928** Niederwartha, Germany:  
Two horizontal radial pumps;  
P: 20.5 MW, H: 154 m.
- 1954** Luenersee, Austria:  
First pump with a head exceeding 1000 m.
- 1964** Säckingen, Germany:  
4 horizontal two stage back-to-back  
arranged radial pumps  
P: 70 MW, H: 410 m.
- 1967+** Roßhag, Austria:  
**1973** 4 vertical two stage radial pump  
P: 52 MW, H: 690 m.
- 1967+** Tehachapi, USA:  
**1979** 10 vertical 4 stage radial pump  
P: 57 MW, H: 600 m.
- 1970** Hornbergstufe-Wehr, Germany:  
Four horizontal two stage double suction radial  
pumps for pumped storage,  
P: 250 MW, H: 666 m, Q: 36 m³/s.
- 1973** Malta Hauptstufe, Austria:  
Two storage pumps with 140.7 MW each  
and 1100 m head, equipped with synchronizing  
converters with gear coupling.
- 1981** Häusling, Austria:  
Two storage pumps with 178.5 MW each  
and 726 m head, equipped with synchronizing  
converters with gear coupling.
- 1990** Säckingen, Germany:  
One storage pump with 84.4 MW and 410,8 m  
head, as a replacement of one storage pump deliv-  
ered in 1964.
- 1992** Riva del Garda, Italy:  
One storage pump consisting of mixed-flow booster  
pump (H: 27 m) and radial flow pump (H: 543 m,  
three stages) connected to the shaft line of a Pelton  
turbine and motor-generator.
- 1992** Yang Zhuo Yong/Tibet, China:  
Four storage pumps with 19.1 MW each, six stages  
with gear coupling for connection in standstill.
- 1999** Pont Ventoux, Italy:  
One storage pump with 73.4 MW and 519 m head,  
connected to the shaft of a splitter type Francis  
turbine with gear coupling.
- 2004** Kops II, Austria:  
Three vertical three stage radial pumps for  
pumped storage,  
P: 152 MW, H: 784 m.
- 2008** Koralpe, Austria:  
One vertical three stage radial pump for  
pumped storage,  
P: 38 MW, H: 740 m.
- 2011** Hongrin Léman, Switzerland:  
2 vertical 5 stage radial pumps for pumped storage,  
P: 118 MW, H: 865 m.

### Torque Converters

- 1954** Luenersee, Austria:  
Five torque converter in vertical arrangement  
for pump start-up,  
P-Converter: 33 MW.
- 1964** Säckingen, Germany:  
Four horizontal arranged torque converter,  
P-Converter: 40 MW.
- 1967+** Roßhag, Austria:  
**1973** Four vertical arranged torque converter,  
P-Converter: 31 MW.
- 1970** Hornbergstufe-Wehr, Germany:  
Four horizontal arranged torque converter  
with the highest converter power today,  
P-converter: 150 MW.
- 1973** Malta Hauptstufe, Austria:  
Two vertical arranged torque converter,  
P-converter: 75 MW.
- 1981** Häusling, Austria:  
Two vertical arranged torque converter,  
P-converter: 100 MW.
- 2004** Kops II, Austria:  
Three vertical arranged torque converter,  
P-converter: 80 MW.



Voith Hydro Holding GmbH & Co. KG  
Alexanderstraße 11  
89522 Heidenheim, Germany  
Tel. +49 7321 37 0  
Fax +49 7321 37 7828

[www.voith.com](http://www.voith.com)

A Voith and Siemens Company

**VOITH**  
Engineered Reliability