

VOITH

nextlevel

by Voith Paper — N° 07

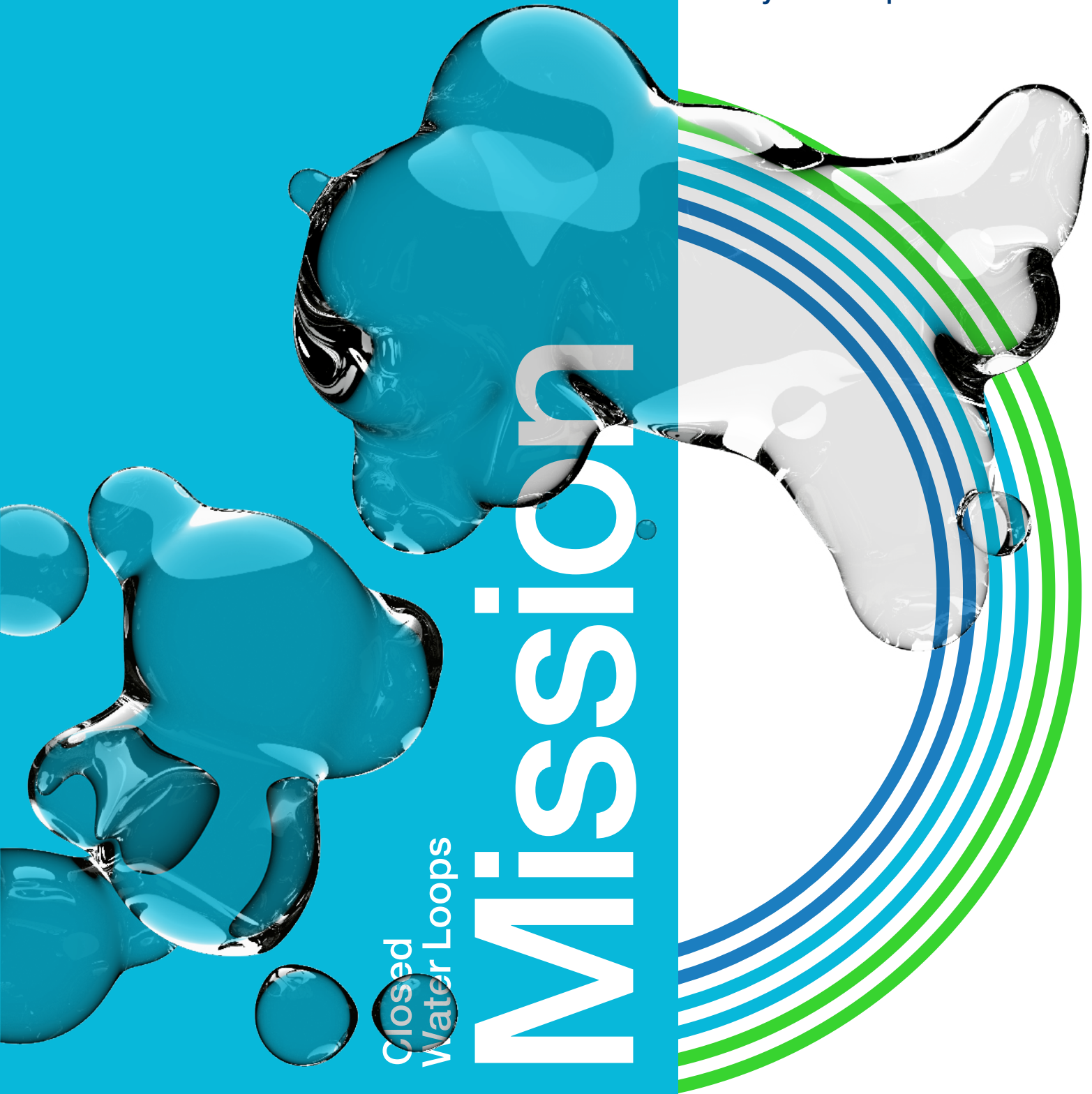

Closed
Water Loops

Mission

nextlevel

by Voith Paper — N° 07

→08

Full-line supplier:
In PM 4, Green Bay Packaging receives
a high-performance testliner
production line from one single source

→26

Barrier paper testing:
Pilot coater at the Voith Technology Center
can be used to test up
to 18 different coating options

→42

OnCare.pmPortal:
The asset management tool keeps
track of product status and
remaining life of consumables

Zero

→30

Sustainable
water management
concepts for
resource-friendly paper
production

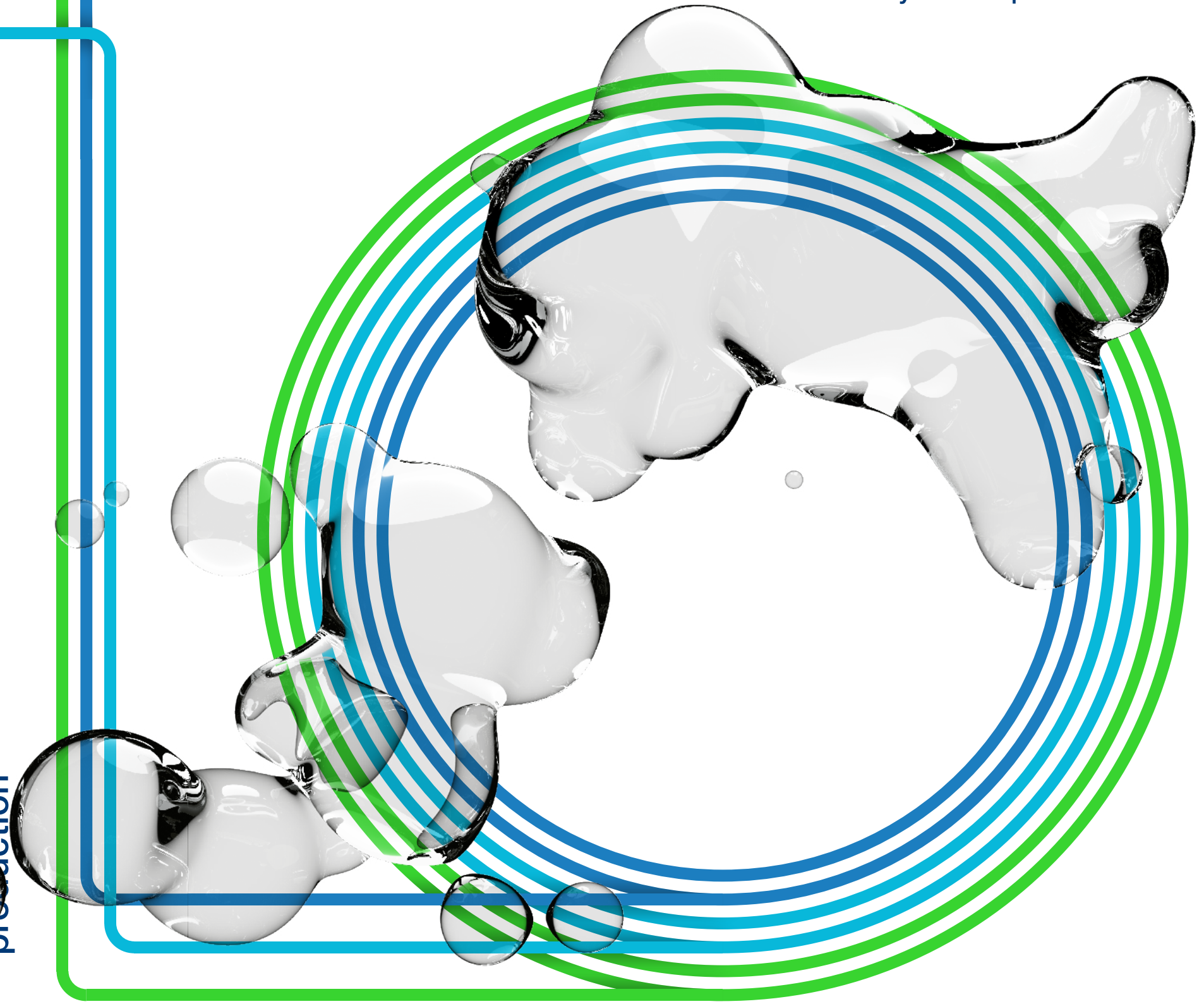



Dear Readers,

Even in challenging times, we continue to demonstrate customer centricity and reliability across the globe. In the process, we are making our mark with numerous BlueLine stock preparation lines and XcelLine paper machines that have come on stream in Asia – these new lines significantly reduce energy, fiber and water consumption. As a result, several of our customers in China are already doing their part today to help the country achieve its goal of carbon neutrality by 2060. Voith production lines were also brought on stream in the United States and Mexico – in the middle of the coronavirus pandemic. A truly notable highlight of Green Bay Packaging's PM 4 is that Voith, as a full-line supplier, is the first company in the history of the U.S. paper industry to be awarded a contract for a complete paper production line. Our modernized pilot coater is another example of how we are increasing sustainability. The latest coating and drying technologies offer our customers a wide range of testing options, such as for barrier paper. In addition, in this issue we reveal how our customers are optimizing their resource and cost-effectiveness as well as product quality with the help of our Paper-making 4.0 solutions. I hope you enjoy this reading adventure full of new discoveries!

Andreas Endters

Andreas Endters
President & CEO Voith Paper



08

Green Bay Packaging's PM 4 makes Voith the first company in the history of the U.S. paper industry to supply a complete paper production line



26

The conversion of the pilot coater at the Technology Center in Heidenheim opens up new testing possibilities

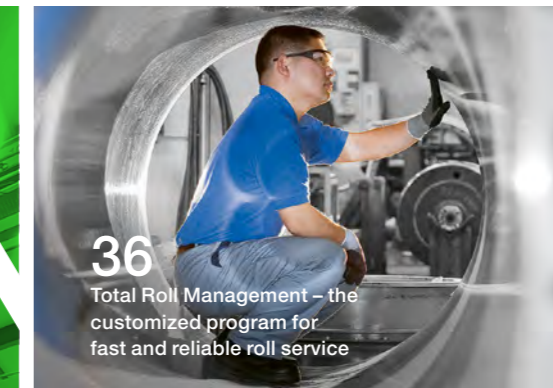

36

Total Roll Management – the customized program for fast and reliable roll service

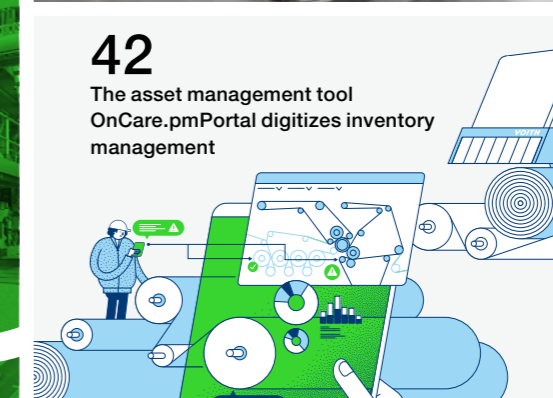

42

The asset management tool OnCare.pmPortal digitizes inventory management

Contents

- 04 **Zoom**
IntensaDrum Duo – A New Dimension
Efficient pulping leads to higher stock consistency – water and energy savings included
- 06 **News**
Brief Reports
from the world of Voith Paper



20

Groundbreaking projects that are driving resource conservation in the Asian paper industry

Full-line supplier

- 08 **Tribute to Marguerite**
Voith makes history with the delivery of the PM 4 to Green Bay Packaging
- 12 **Mix It!**
HydroMix sets new standards by efficiently blending the thick stock and homogeneously mixing it into the whitewater
- 13 **New Lines**
Sofidel expands market presence thanks to new tissue lines from Toscotec
- 14 **Shared Success**
New PM 7 helps Grupo Gondi achieve its goal of further expanding the market in Latin America
- 16 **One-Stop Shop**
With its expertise as a full-line supplier, Voith has developed a unique comprehensive service for spare parts
- 18 **Sensors Optimize Mass Balance**
Consistency solutions from BTG and Voith improve energy and feedstock use

Sustainability

- 20 **Start-ups in Asia – Roadmap to Sustainability**
New production lines help make an entire region's paper manufacturing processes more sustainable
- 26 **An Extra Layer in Sustainability**
Greater flexibility and new options for testing barrier and coated paper at the Technology Center in Heidenheim
- 30 **Mission Zero**
AquaLine water management reduces process effluent volume and carbon footprint
- 34 **A New Lease on Life**
How refurbishing vacuum pumps, screw presses, disc filters and CombiSorters increases system productivity
- 36 **Keeping Customers' Processes Rolling**
Customized Total Roll Management maximizes availability and performance

Efficiency

- 38 **Go Digital – Next Stop: Autonomy**
Digitalization optimizes stock preparation processes
- 42 **Complete Control**
Manage inventories and monitor product statuses and service lives with the OnCare.pmPortal
- 46 **Data-driven**
Stable processes and enhanced paper quality via OnEfficiency.Strength
- 48 **Creating Value from Data**
OnCumulus sets new standards in process monitoring and control
- 49 **It Keeps Going and Going and Going**
The IntensePress roll cover increases durability, extends roll service life and simplifies operations
- 50 **A + for Greater Efficiency**
The +Pro, +Peak and +Up Add-Ons increase the efficiency of press felts
- 51 **Q&A**
How the industry will achieve carbon neutrality

Publishing Information

Publisher:
J.M. Voith SE & Co. KG
St. Poeltener Str. 43
89522 Heidenheim, Germany
nextlevel@voith.com

Responsible for Content:
Anna Dennerlein,
J.M. Voith SE & Co. KG

Editor-in-chief:
Julia Schaefer,
J.M. Voith SE & Co. KG

Editorial work:
ecomBETZ PR GmbH,
Schwäbisch Gmünd, Germany

Design:
stapelberg&fritz gmbh,
Stuttgart, Germany

Printing:
C. Maurer GmbH & Co. KG,
Geislingen an der Steige, Germany

Copyright:
No part of this publication may be reproduced, distributed, or transmitted in any form or by any means without the prior written permission of the publisher and none of the content contained herein may be used in whole or in part in other works in any form.

Photo credits:
Cover page: s&f (illustration) / youworkforthem (rendering)
pp. 04–05, 12, 30–31 : Ray Sono AG (rendering)
pp. 08–11: Alison Suski (Image Studios)
p. 12 (background): youworkforthem
p. 13: Toscotec
pp. 14–15: s&f (rendering) / Grupo Gondi (photo)
pp. 15, 16, 27, 32–33, 39, 51: Jan Steins (portrait)
pp. 16–17, 42–45: Axel Pfaender (illustration)
pp. 18, 48: shutterstock
pp. 20–25: s&f (illustration)
pp. 25, 39, 40, 41: Jan Hosan (photo)
pp. 30–33: s&f (illustration) / youworkforthem (rendering)
pp. 46–47: Stoll von Gati (rendering)
All other photos are from Voith.

Your feedback:
If you have any questions or comments about this issue of nextlevel, please contact us by email at nextlevel@voith.com or via:
www.linkedin.com/company/voith-paper
www.youtube.com/voithgroup

LinkedIn YouTube

voith.com



A New Dimension

1 The IntensaDrum Duo's simple operating principle makes maintenance quick and easy.

2 The fast and selective addition of water between the pulping and screening sections reduces fiber losses.

– Including When It Comes to Sustainability

48^m
Length
Pulping section

23^m
Length
Screening section

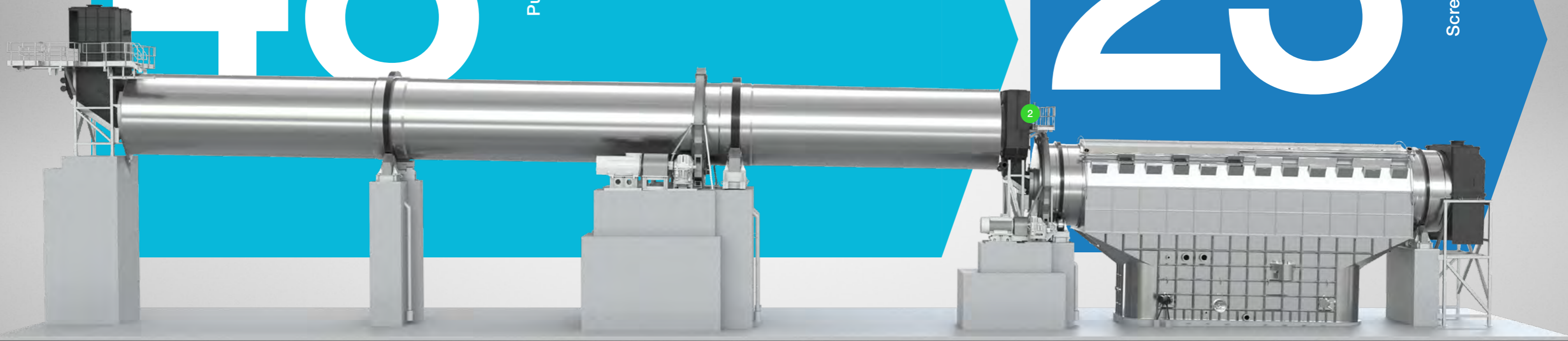

IntensaDrum Duo

The IntensaDrum Duo sets a new benchmark in the field of efficient pulping – and not just because of the size of the system. The drum pulper's pulping and screening sections together measure 71 meters in length. With all of the upstream and downstream components, the line comes to a total length of 78 meters. The size is tailored to the raw material quantity. The drum processes around 3,000 tons of recovered paper every day. But quantity is only one of the factors the IntensaDrum Duo utilizes to make paper production more sustainable. The technology developed

by Voith also permits a higher stock consistency than with conventional drum pulping, which translates into significantly lower water and energy consumption. The water remains in a closed circuit and is reused. The technology behind the system is based on the tried and tested IntensaDrum – reimagined in new dimensions. Besides, the underlying design – with virtually no moving parts and therefore hardly any wear – allows for easy and quick maintenance.

Demand Increasing for the OnQuality Quality Control System

A growing number of paper manufacturers are using the OnQuality quality control system as the basis for improving their production quality. In addition to numerous other international customers, UPM and Simka Kagit have also been relying on its innovative technology since the spring of 2021. By integrating the system into its PM 6 located in Schongau, Germany, UPM, the world's leading manufacturer of graphic papers, not only intends to stabilize and optimize its processes but also increase mill productivity and reduce operating and maintenance costs. Similarly, Simka Kagit, a Turkish manufacturer of various converted paper and paperboard products, also engaged Voith in the spring to equip its PM 1 in Kayseri with the quality control system's latest generation of scanners and sensors. In this case as well, the focus was on further increasing production quality and efficiency. In addition to numerous physical sensors, the latest version of OnQuality deployed at UPM and Simka Kagit offers users virtual sensor applications and seamlessly integrates with the OnCumulus cloud platform. As a result, the system lays the foundation for the digitalization of a paper mill.

Complete Conversion of Papresa's PM 5

Papresa, one of the leading Southern European newsprint producers, has commissioned Voith to convert its PM 5 paper machine located in Rentería, Spain. To this end, Voith will perform extensive upgrades on all of PM 5's different sections, thereby laying the foundation for the efficient and sustainable production of lightweight packaging paper. In addition, Papresa has opted for comprehensive services and digital solutions from Voith's Papermaking 4.0 portfolio in order to lay the foundation for a digital paper mill of the future. The machine, which until now has produced newsprint, is scheduled to start the production of packaging paper in the first quarter of 2022. This is now the second contract Voith has received from Papresa in 2021 – earlier this year, the company ordered a new BlueLine OCC stock preparation line for its Rentería mill.



To date, Papresa's PM 5 produces newsprint paper

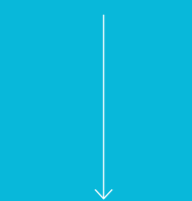

After conversion, the focus will be on the production of lightweight packaging grades



Efficient and Safe Threading

The Voith TailStabilizer significantly increases efficiency – so much so, in fact, that it has already impressed a major Chinese paper manufacturer. It is the first system in the world that makes ropeless threading of the paper web possible in two-tier dryer sections of board machines – at paper weights of up to 300 g/m². The solution is part of Voith PrevoSystems, a product line of fully automated zone-controlled threading systems. In addition to increasing efficiency through shorter downtimes after sheet breaks and reducing the resulting high maintenance costs, the system's key benefit is that it improves safety for operating personnel. This is because manual, and therefore also dangerous, operations are no longer necessary with ropeless threading using the Voith TailStabilizer. In addition, it prevents unplanned downtime due to broken ropes and reduces the risk of injury.

On a technical level, this newly developed solution works as follows: A specially developed peel-up component is positioned as close as possible to the roll. The optimized arrangement of multi-row air nozzles and air deflectors lifts the tail from the drying cylinders and quickly affixes it to the TailStabilizer to transport it from there to the next drying cylinder. "This is an efficient, fully automatic, and safe threading system that is particularly suitable for rebuilds and optimizations of existing threading systems," says Sebastian Meuthen, Product & Service Manager Paper Machine at Voith.

#YOUR FULFILL LINE SUP PLIER

Discover the potential of holistic papermaking solutions.

p. 07 —————> 18



Tribute to Marguerite

Green Bay Packaging's PM 4 is named "The Marguerite K." But this tribute to the wife of the company's founder is not the only aspect that makes the machine so special. For the first time in the history of the U.S. paper industry, a single company was awarded the order to supply a complete paper production line. That company was Voith.



PM 4 more than doubles production capacity at the Green Bay facility.



More than 800 sensors provide the OnCare.Health condition monitoring system with data.



Marguerite is the French form of the forename Margaret, and not necessarily the first name you would associate with a paper machine. Green Bay Packaging's new PM 4, which started producing testliner in March 2021, has been given this name as a tribute to the wife of the company's founder, George F. Kress. In the company's early years, Marguerite Kress was an important factor in its initial successes. She worked in the company until 1935, and thereafter, was also heavily involved in the company's ongoing development.

It is therefore perfectly logical to see the name "The Marguerite K" as a reflection of the company's essence: By giving the PM 4 this name, the family-owned company is acknowledging its roots. This aspect is underscored by Matthew Szymanski, Vice President of Mill Operations at Green Bay Packaging: "The new production line is a clear statement that we believe in the long-term future of the corrugated packaging industry. At the same time we are creating a lot of new jobs in Brown County and in the state of Wisconsin, exactly where we come from." →



Green Bay Packaging is using the XcellLine paper machine to produce testliner at basis weights of between 18 and 56 lbs/1,000 ft² (88 and 273 g/m²). “The stock preparation line is a crucial factor in ensuring reliably high quality in this broad range,” explains Matthew Szymanski from Green Bay Packaging. The company plans to produce 685,000 short tons (621,422 metric tons) of paper a year on the PM 4. “The new system is allowing us to more than double our production capacity at the Green Bay facility,” stresses Szymanski.

On the PM 4, comprehensive automation and digitalization solutions ensure a stable production process and efficient work flows. And this is where you’ll find another first, says Rimpf: “The sensors used in the OnQuality quality control system are highly efficient yet are currently the smallest on the market. This substantially reduces the installation space required.” The QCS passes on the data it collects to the OnCumulus cloud platform, whose analyses and evaluations provide operators on site with important tips on process optimizations. Moreover, with the OnPerformance.Lab and artificial intelligence, Voith experts can gain an overview of the production line and optimize machine behavior.

Jack Rimpf can name yet another record-breaker in the field of digitalization and automation: “The PM 4 is equipped with the condition monitoring system OnCare.Health, for



The BlueLine stock preparation processes up to 1,862 short tons (1,690 metric tons) of feedstock per day.



The first reel of paper was produced at PM 4 on March 11, 2021.

But it is not just this affirmation that makes the formidable Marguerite so unique. The PM 4 is also the first new build of a paper machine in Wisconsin, in the heart of “Paper Valley,” in more than 35 years. And for the first time in the history of the U.S. paper industry, a single company was awarded the order to supply a complete paper production line. That company was Voith. A look at the production line reveals further superlatives and premieres.

For example, at the time of awarding the order, the stock preparation unit was the largest of its kind in the U.S. It processes up to 1,862 short tons (1,690 metric tons) of feedstock per day, consisting exclusively of recovered paper. To ensure the high quality of the testliner produced, Voith equipped the BlueLine stock preparation line with innovative technology. “This means the facility can still guarantee a high fiber quality even if the proportion of mixed recovered paper is particularly high,” explains Johannes Rimpf, also known as Jack, Senior Project Manager at Voith. At the same time, the products of the BlueLine stock preparation including IntegraScreens, InfiltraDicfilters and InfibraFiners allow for a maximum flexibility. The highly purified fiber suspension from the stock preparation line is important for minimizing web breaks during paper production and thus improving the efficiency of the system.



Green Bay PM 4 The Marguerite K

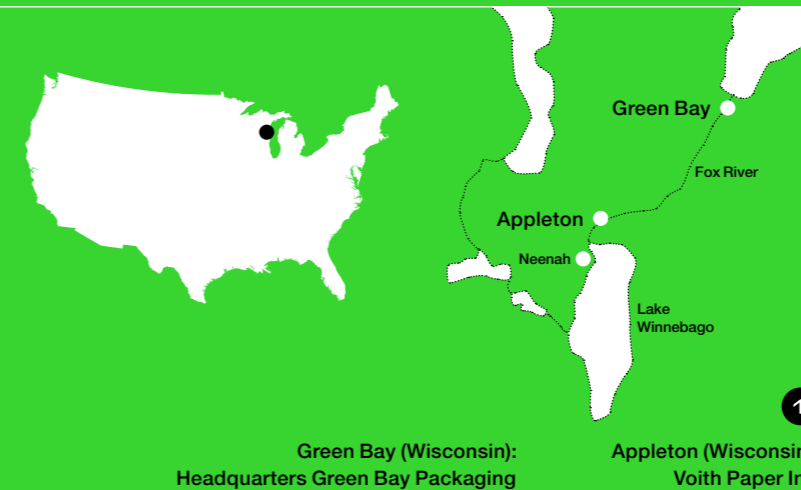

Green Bay (Wisconsin):
Headquarters Green Bay Packaging

Appleton (Wisconsin):
Voith Paper Inc.

“The new production line is a clear statement that we believe in the long-term future of the corrugated packaging industry.”

Matthew Szymanski
Vice President of Mill Operations, Green Bay Packaging



ization solutions ensure
ses.

ccompany the Marguerite K (from left):
gional President Voith Paper North America),
ent & CEO Green Bay Packaging),
ecutive Vice President Green Bay Packaging),
Vice President of Mill Operations Green Bay
Rimpf (Senior Project Manager Voith Paper).

that all our requirements were being met
is running smoothly.” At the same time,
ject to a full-line supplier substantially re-
nterface problems between various
components. All components, technolo-
s and services are precisely matched to
Rimpf, who moved to the U.S. to oversee
ction of the facility in his capacity as Voith
underlines: “Green Bay Packaging has
n a fully integrated plant that is tailored pre-
mer’s requirements.”
start-up of the PM 4, Voith and Marguerite
neir separate ways. The full-line supplier
rovide support to the facility on the basis of
ng and remote servicing solutions. Voith
a presence on site, for example due to the
vice agreement and clothing package
the paper machine ordered by Green Bay



Green Bay PM 4 Facts & Figures

- **Start of construction: August 2018**
- **Start-up: March 2021**
- **Paper grade: testliner**
- **Basis weights: 18 to 56 lbs/1,000 ft² (88 to 273 g/m²)**
- **Wire width: 8,400 mm**
- **Construction speed: 1,200 m/min**
- **OnCare.Health condition monitoring system with more than 800 sensors**
- **Annual production capacity: 685,000 tn.sh. (621,422 t)**



The BlueLine stock preparation processes up to 1,862 short tons (1,690 metric tons) of feedstock per day.



The first reel of paper was produced at PM 4 on March 11, 2021.

But it is not just this affirmation that makes Marguerite so unique. The PM 4 is also the first paper machine in Wisconsin, in the heart of the U.S. paper industry, a single company was Voith. A look at the production process reveals their superlatives and premieres.

For example, at the time of awarding the contract, the stock preparation unit was the largest of its kind. It processes up to 1,862 short tons (1,690 metric tons) of feedstock per day, consisting exclusively of softwood chips. To ensure the high quality of the testliner product, Voith equipped the BlueLine stock preparation line with the latest technology. "This means the facility can still produce a high fiber quality even if the proportion of softwood chips is particularly high," explains Johann Rimpf, known as Jack, Senior Project Manager at Voith. At the same time, the products of the BlueLine stock preparation line, including IntegraScreens, InfiltraDicfilters and Infiltra, provide for a maximum flexibility. The highly purified water from the stock preparation line is important to prevent web breaks during paper production and to ensure the efficiency of the system.

“Green Bay Packaging has been supplied with a fully integrated plant that is tailored precisely to the customer’s requirements.”

Jack Rimpf
Senior Project Manager Voith Paper

which we installed more than 800 sensors, which is likely to be a record in North America.” And it will also help Green Bay Packaging to optimize its maintenance activities and avoid unscheduled downtimes.

Voith’s scope of supply also included a VariFlex Performance winder that was assembled at the Voith workshop in Appleton. Appleton’s proximity to Green Bay allowed Green Bay Packaging to track and witness the winder’s assembly progress. After assembly and testing was completed successfully, the VariFlex Performance winder was ready for shipment to its permanent home 29 miles away in August 2020.

The supplied reject handling system is the first fully automated system of its kind in the U.S. and improves the availability and efficiency of the PM 4. Voith subsidiary Voith Meri Environmental Solutions, Inc., was in charge of implementation and also designed and built the effluent treatment system. “Green Bay Packaging wanted an innovative system that produces as little effluent volume as possible and leaves only a small carbon footprint behind,” explains Rimpf. To this end the Aqualine Flex System was also fitted with what is known as a “biological kidney,” which treats the process water in such a way that it can largely be returned to the production process. The facility is also designed so that only a minimal amount of sludge occurs in the anaerobic system. “Together with our municipal effluent treatment plant, we developed a concept that makes us completely independent of the nearby Fox River,” adds Jonathon Gates, Project Manager at Green Bay Packaging.

It is no coincidence that Green Bay Packaging trusted Voith to deal with almost all aspects of this special project, as the two companies enjoy a longstanding partnership. “Our relationship has grown constantly over the years. The Voith team has in-depth knowledge of our facilities and our objectives,” says Szymanski. In recent years, Voith had already demonstrated its capabilities and leading technological expertise at various Green Bay sites, e.g., for the Morrilton PM 1 in Arkansas. This excellent experience was one of the deciding factors when it came to awarding the contract.

Jonathon Gates also underlines the benefits of working with just one company: “We only ever had one partner to call



Automation and digitization solutions ensure more efficient processes.



They will continue to accompany the Marguerite K (from left): David Buchanan (Regional President Voith Paper North America), William Kress (President & CEO Green Bay Packaging), Bryan Hollenbach (Executive Vice President Green Bay Packaging), Matthew Szymanski (Vice President of Mill Operations Green Bay Packaging) and Jack Rimpf (Senior Project Manager Voith Paper).

and could be sure that all our requirements were being met and everything was running smoothly.” At the same time, entrusting the project to a full-line supplier substantially reduces the risk of interface problems between various project phases or components. All components, technologies, sub-systems and services are precisely matched to one another. Jack Rimpf, who moved to the U.S. to oversee the entire construction of the facility in his capacity as Voith project manager, underlines: “Green Bay Packaging has been supplied with a fully integrated plant that is tailored precisely to the customer’s requirements.”

Even after the start-up of the PM 4, Voith and Marguerite will not be going their separate ways. The full-line supplier will continue to provide support to the facility on the basis of its digital monitoring and remote servicing solutions. Voith will also maintain a presence on site, for example due to the multi-year roll service agreement and clothing package for all sections of the paper machine ordered by Green Bay Packaging.



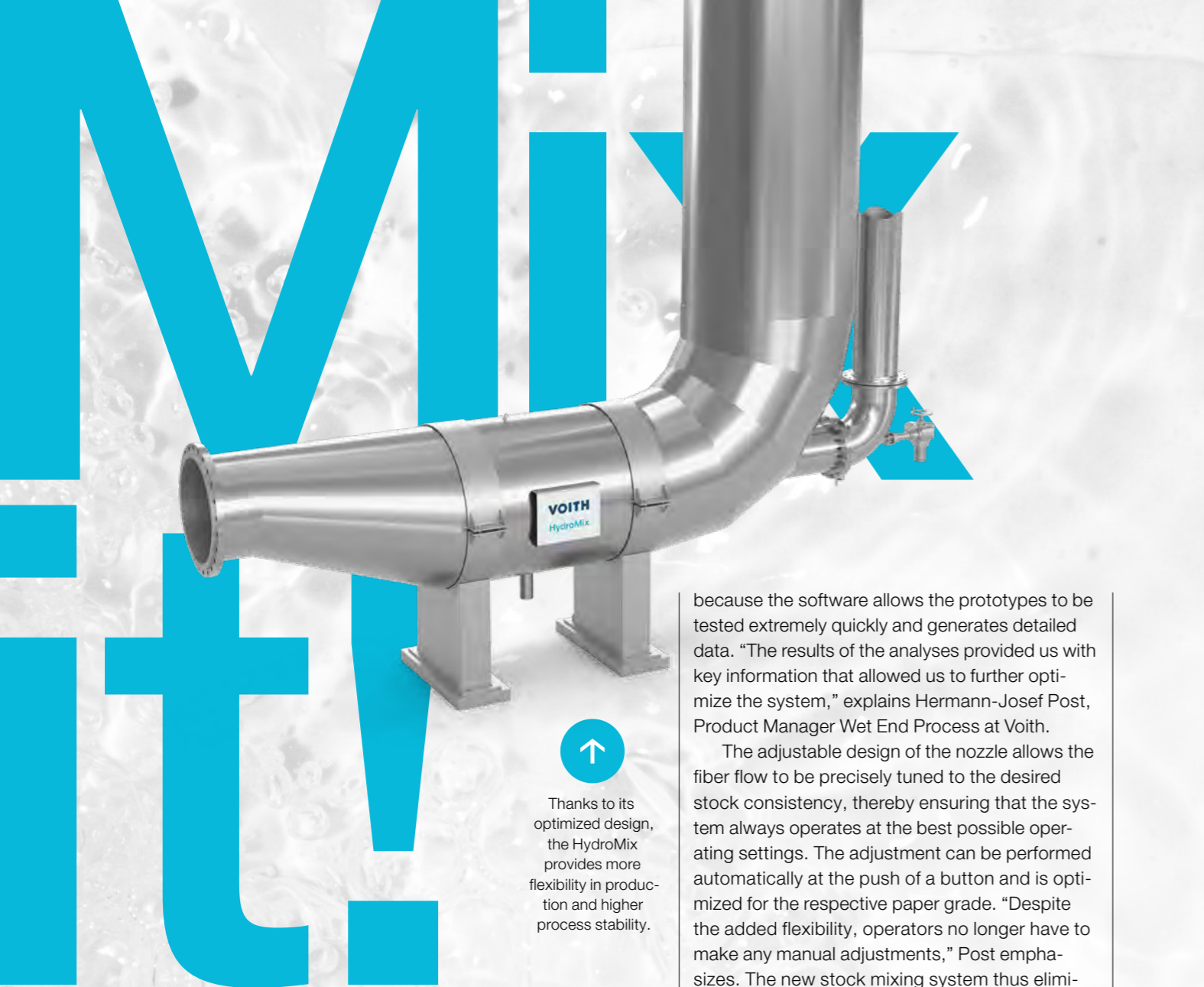

Thanks to its optimized design, the HydroMix provides more flexibility in production and higher process stability.

because the software allows the prototypes to be tested extremely quickly and generates detailed data. “The results of the analyses provided us with key information that allowed us to further optimize the system,” explains Hermann-Josef Post, Product Manager Wet End Process at Voith.

The adjustable design of the nozzle allows the fiber flow to be precisely tuned to the desired stock consistency, thereby ensuring that the system always operates at the best possible operating settings. The adjustment can be performed automatically at the push of a button and is optimized for the respective paper grade. “Despite the added flexibility, operators no longer have to make any manual adjustments,” Post emphasizes. The new stock mixing system thus eliminates a source of errors and enhances the stability of the process.

But the nozzle isn’t the new HydroMix’s only innovation, as Post points out: “During the simulations, we conducted intensive research to ensure that the whitewater flows perfectly toward the nozzle.” The result is an acceleration elbow that prevents turbulence, facilitates the homogeneous mixing of thick stock and whitewater, and significantly extends the operating window of the new HydroMix. In this context, it covers a total stock flow rate of 1,000 to 40,000 liters per minute, thereby meeting the individual needs of papermakers from specialty paper producers to board manufacturers. Another advantage of the new HydroMix is that thanks to a mixing zone that is about 50 percent shorter, the entire unit is significantly more compact than the previous model. “This allows the system to be used when installation space is limited and also reduces construction costs,” Post says.

A Stock Mixing Star

An extended operating window and more homogeneous headbox stock flows are just two of the key advantages of the latest generation of the HydroMix stock mixing system.

The launch of Green Bay Packaging’s PM 4 in March 2021 also marked the premiere of the latest generation of the HydroMix stock mixing system. By efficiently blending the thick stock as well as homogeneously mixing it into the whitewater, it extends the operating window and gives papermakers greater flexibility in the production of a wide range of basis weights.

The centerpiece of the enhanced system is a patented, adjustable star-shaped nozzle. Its shape and structure were designed by a development team based on extensive simulations of the flow conditions, a process known as CFD analysis. The process is particularly efficient



With a web width of 5,500 mm and an operating speed of 2,000 m/min, Sofidel’s two new production lines each produce up to 60,000 tons of tissue paper per year.

New

“The cooperation with Sofidel was excellent and enabled us to successfully commission the two tissue production lines in accordance with U.S. standards and Sofidel’s quality requirements. The machines have now been running for several months to the complete satisfaction of the customer.”

Marco Dalle Piagge
Sales Director, Toscotec

Two new AHEAD 2.0L tissue lines from Toscotec in Inola, Oklahoma, enhance Sofidel’s position in the U.S. market.

Lines

Both AHEAD 2.0L tissue machines, which were delivered to one of the world’s leading tissue paper manufacturer with sites in 12 European countries and the United States, are equipped with the particularly efficient TT SYD (Steel Yankee Dryer). “Achieving a high level of energy efficiency throughout the entire manufacturing process plays an extremely important role in the development of our tissue lines,” explains Marco Dalle Piagge, Sales Director at Toscotec. “Our TT hood helps recover a significant amount of energy and reduces gas consumption.” In addition to the stock preparation, electrical and control systems, Toscotec lived up to its excellent reputation as a supplier of turnkey projects and supplied the dust and mist removal systems and its patented TT SAF (Short Approach Flow) system. The project in Inola, Oklahoma, also encompassed hall ventilation, water treatment and chemical preparation systems, and roll packaging systems.

Toscotec’s next major project – the delivery of two TADVISION® tissue machines to the Chinese Hengan International Group – is already underway. The new lines will be the first machines in China to use the company’s tried-and-tested TAD (Through Air Drying) technology. The unique serpentine arrangement of the coated TAD drums optimizes the airflow, which helps dry the paper evenly and reduces energy consumption.

The owners Fernando and Alejandro González and Grupo Gondi CEO Eduardo Posada selected the name “Musketees” for a new recycled container-board machine project deliberately. Thanks to the converging objectives of the shareholders, the Executive Board, and senior management, Grupo Gondi successfully launched the largest project in its history. And in the spirit of the Three Musketeers, each party leveraged its best qualities to contribute to the collective success – the expansion of the company’s market position for recycled corrugated base paper in Latin America.

Shared Success



← With the “Musketees,” Grupo Gondi’s annual production volume increases to over 1 million tons of recycled paper.

→ Sustainable expansion of market position in Latin America – low basis weight recycled containerboard is produced on PM 7.

“All for one and one for all, united we stand, divided we fall.” The Three Musketeers’ motto has become synonymous with unity, solidarity and the powerful pursuit of common goals. “Bringing PM 7 onstream at our newest packaging plant in Monterrey is an important step for us. Working closely with Voith, we continue to expand our market position in this way. From the beginning, we wanted each party to leverage its unique strengths and experience to ensure the project was a complete success, which is why we named it ‘Musketees,’” says Grupo Gondi CEO Eduardo Posada, adding, “the purchase of the new paper machine was the largest investment in our company’s history to date.”

Expressed in figures, expanding the company’s market position involves 400,000 tons of lightweight, recycled corrugated base paper, with the new PM 7. “As a result, we are increasing our production capacity to more than one million tons of recycled paper per year, and at the same time, thanks to PM 7, we are giving sustainable paper production in Latin America a much-needed boost,” Posada is certain.

Christian Deide, Project Manager at Voith, can only agree: “This machine is designed to be extremely flexible, after all.” Dr. Felix Rocha Echeverria, Business Unit Manager Paper at Grupo Gondi, explains what he means by flexibility. The recycled fiber plant can use both short fibers, mainly from Mexican OCC, and long fibers mainly from imported OCC. “This means we can adapt to the fiber supply in Mexico as well as in the southern United States extremely well and won’t have any issues when it comes to the raw material supply,” Dr. Rocha explains.

1 Well located in Monterrey, Mexico with proximity to the U.S.



2 Voith supplied the complete production line.

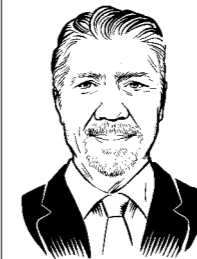

“From the beginning, we wanted each party to leverage its unique strengths and experience to ensure the project was a complete success.”

Eduardo Posada
Grupo Gondi CEO

Voith and Grupo Gondi have already worked together successfully on various smaller projects, with Voith components installed in numerous areas of the Mexican company’s six existing machines. But the “Musketees” project was the first time Voith supplied a complete production line to Grupo Gondi. The order encompassed the complete BlueLine stock preparation line, including reject handling and feeding systems, the approach flow system, and the XcellLine paper machine, as well as the MasterReel reeling solution. In addition, powerful automation solutions were also part of the package, such as the Machine Control System (MCS) or the OnQuality Quality Control System (QCS). “We now produce high-quality recycled board, testliner and corrugated base paper grades in the basis weight range from 85 to 250 g/m² on the PM 7 over a web width of 6,600 mm and at a design speed of 1,200 m/min,” Dr. Rocha says proudly, describing the line’s broad range of applications.

In this context, the Three Musketeers’ motto also had a positive effect on the entire construction and installation phase at the Monterrey plant, which is located around 200 kilometers southwest of the U.S. border. “Despite the coronavirus pandemic and the resulting contact and travel restrictions, we could continue to closely collaborate without any interruptions using the OnCall.Video audiovisual communication system,” says Project Manager Deide.



Björn Kleigrewe
Solution Manager
Spare Parts at Voith

It may be just a nozzle or a valve that stops working, but before you know it, the entire production line comes grinding to a halt. To ensure that the right spare parts are on hand when they are needed, proper stocking is just as important as an efficient ordering and delivery process. Voith offers customers both from a single source and complements its expertise as a full-line supplier with a unique service.

Shop ^{One-Stop}

Analyze

Identify

Place the Order

Receive the Parts

With its detailed knowledge of the paper-making process, Voith supports customers in achieving one of their primary goals: maximizing machine availability, for example by preventing unplanned shutdowns. It accomplishes this primarily by ensuring that spare parts are readily available. Customers can choose the right products from a range of over 130,000 different parts while simultaneously benefiting from an efficient and digital procurement process. As a system supplier of new lines, rebuilds, services, wear parts and digital solutions, Voith knows all of the parts inside out and offers a coordinated range of services and products. This ensures that customers also receive the best possible support in the form of services, such as consulting on optimal spare parts inventory management.

With this “one stop shop” approach, Voith has made its spare parts business even simpler and faster, also via the Voith Paper Webshop. A look at the customer journey through the spare parts process shows why it pays off to order high-quality spare parts from Voith.

Analyze

Prepare for Planned Shutdowns

The necessary spare parts must be ordered and stocked well in advance of planned shutdowns or regular maintenance. Due to its system expertise and large portfolio, Voith offers its customers a combination of spare parts as well as maintenance and services. This allows papermakers to conveniently source everything from a single supplier and ensures that the right part is available at the right time.

Ensure Minimum Stock Levels

When ordering a new line, customers already have the option of adding a spare parts package to their order that

includes all parts relevant to the machine. “Having a minimum stock of spare parts on site is essential in order to keep downtimes during planned and unplanned shutdowns as short as possible,” says Bjoern Kleigrewe, Solution Manager Spare Parts at Voith. Once the machine has been in operation for some time, the customer receives a recommendation regarding which additional parts it needs to stock in order to maximize machine availability. This is based on the spare parts lists of the new machines and the customer’s current stock levels. “As part of this inventory consulting service, we advise customers on how to minimize risks by stocking particularly important spare parts,” adds Kleigrewe.

Deal with Emergency Situations

When it comes to the rapid availability of spare parts, there is no doubt that one of the most critical moments is the unplanned failure of one of them. Ideally, the customer already has the urgently needed spare parts on hand. If not, Voith Paper’s Webshop can help – it provides real-time information on the immediate availability of spare parts and allows customers to order a wide range of parts online in the shortest possible time. In addition, customers can receive the orders via express delivery.

Identify

Every production line is configured differently according to the customer’s specific needs. This means that several thousand spare parts have to be assigned and identified for each machine. But which pump is the right one? Which parts are needed in order to fix a leak in the piping system, or which disc filters? Customers can, for example, immediately find all the relevant information online by navigating through the Webshop. In addition, the regional customer service centers can help. To replace older parts and customized

components, a team is also available in the background to provide technical assistance and ensure that customers receive exactly the parts they need.

Place the Order

Customers can view all the spare parts installed in their machine as well as their order history in the Voith Paper Webshop. “Everyone knows the benefits of ordering online from personal experience – the fastest way to order a preferred item is to click through to your order history,” Kleigrewe says. The Voith Paper Webshop is structured in exactly the same way. If customers already have an account, not only can their purchasing departments see the part numbers, but also prices and delivery times. Catalog and EDI interfaces make the ordering process even more efficient and convenient. And in this case as well, Voith’s experts at the customer service centers are available to help customers who don’t yet use this service.

Receive the Parts

When customers place an order from the Webshop, they automatically receive an order confirmation and a shipping notice. “Customers can track where the ordered parts are in real time and when delivery will take place,” says Kleigrewe, adding, “and when the spare part arrives at the customer’s site, it can immediately be correctly identified and either stored, installed or made available to service technicians for planned maintenance work.”

For effective spare parts management, Voith combines in-depth system knowledge, digital solutions and efficient delivery processes into one comprehensive solution. This has a positive effect on papermakers’ bottom line in two different ways – it helps them optimize their own stock management and significantly increase the efficiency of their paper mill.

Consistency is the key parameter in all processes for pulp and paper manufacturing. This means that good consistency management not only optimizes the yield but also improves the quality of the stock and paper and saves raw material and energy costs.

The BTG Group has made a name for itself worldwide with its consistency management solutions. In this context, the Voith subsidiary focuses on a combination of high-quality sensor technology, extensive data analysis and applications experience worldwide. In line with the Papermaking 4.0 concept, BTG's goal is to use its consistency solutions to optimize the use of energy and raw materials, increase the stability and quality of the stock in the process, and reduce costs over the entire production process.

Sensors

optimize
mass balance

Specifically, this involves chemical dosing, mixing ratios, specific energy use, basis weight and of course paper quality.

"Through a remote service option, we offer our customers the opportunity of having us analyze on their behalf the data that is available to us through our cloud connection. This allows us to actively contribute to an optimized production management," says Peter Raser, who has been leading consistency optimization at BTG for over 25 years. With BTG's full-service package, BTG service technicians around the world not only monitor and manage the consistency loops remotely or on-site but actively intervene in the entire consistency cycle, performing calibrations and completely taking over responsibility for high performance of consistency assets.

To control and optimize mass balance in the paper manufacturing process, BTG uses various measuring technologies. Shear force sensors, either using blade or rotating sensors, detect shear force created by the amount of fibers relating to consistency. Microwave



Reliable sensor technology is also the basis for an autonomous stock preparation system (→ p. 38) and OnView.MassBalance (→ p. 48).

technology measures the velocity of microwaves through a fiber suspension where water and fiber have different behavior. Finally, a whole range of optical sensors using transmission and reflection of light complements the full range of technology providing accurate measurements to support corresponding solutions for consistency management throughout a pulp or paper mill.

BTG consistency solutions complemented with Voith's field instruments portfolio of various process sensors and valves form an optimum overall solution for the entire production line.

#SUS TAIN ABLE PAPER MAK ING

Discover the potential of sustainable papermaking.

p. 19 —————> 36

Start up

Road map to sustainability

China's pledge to reach carbon neutrality by 2060 is the driving force behind a major overhaul of the country's industrial sectors. And the booming paper industry? Voith provides the breakthrough technology for leading paper manufacturers to transition to more sustainable papermaking processes.

"China's target of peak emissions before 2030 and carbon neutrality by 2060 has clearly boosted the demand for sustainable technologies across all industrial sectors in the region," explains Kurt Yu, Regional President Voith Paper Asia. "The goal is certainly ambitious, and the clock is ticking," he adds. "We're already seeing its impact on manufacturing industries across the region." Rigorous government policies, for instance, have resulted in astonishing progress in what is bound to be a difficult transition period from fossil-fuels to more sustainable clean energy. While old-fashioned polluting coal-fired power plants are shutting down, the take-up of electrical vehicles is also speeding up. But what does this shift mean for the booming paper industry? →



Small-scale production facilities that consume higher than average levels of energy, fresh water or other resources play no role in this net-zero future. They are already being replaced by modern, large-scale facilities. Production is typically being consolidated into state-of-the-art systems that are engineered for a more sustainable and energy-efficient production. "For the leading paper manufacturers in the region, curbing emissions is clearly high on the agenda," explains Kurt Yu. "As a full-line supplier, Voith is in a unique position to provide the necessary technical support and expertise to support a low-carbon and more efficient papermaking process."

Nine Dragons Paper, Shanying Paper, Sun Paper and Bohui Paper are just four out of the many manufacturers around the world who have benefited from the Voith approach to more sustainable papermaking.

Nine Dragons Paper: low-carbon pact

"No environmental management, no papermaking" is the bold philosophy behind Nine Dragons Paper, Asia's largest manufacturer of recovered paper. It's a statement that succinctly summarizes the company's commitment to green paper manufacturing. It also helps explain why Nine Dragons Paper has partnered with Voith on the company's sole expansion project in the past three years.

In 2017, Nine Dragons Paper ordered no fewer than six BlueLine OCC stock preparation lines from Voith. Five have been in operation since October 2020, while the sixth is scheduled for 2022. Each of the lines is capable of producing up to 2,000 tons per day, and yet the energy savings are considerable. The resource-efficient BlueLine OCC design uses up to 20 percent less energy and saves at least 0.5 percent fibers.

Increased yield

As well as improving energy efficiency, Nine Dragons Paper is also focusing on increasing production capacities with the new paper machines: In January 2021, the group commissioned Voith to supply three XcelLine paper machines designed for particularly sustainable production. Nine Dragons Paper aims to use these machines to extend its product range to include white top testliner with basis weights of between 140 and 250 g/m². A daily production rate of approximately 2,400 metric tons each is planned.

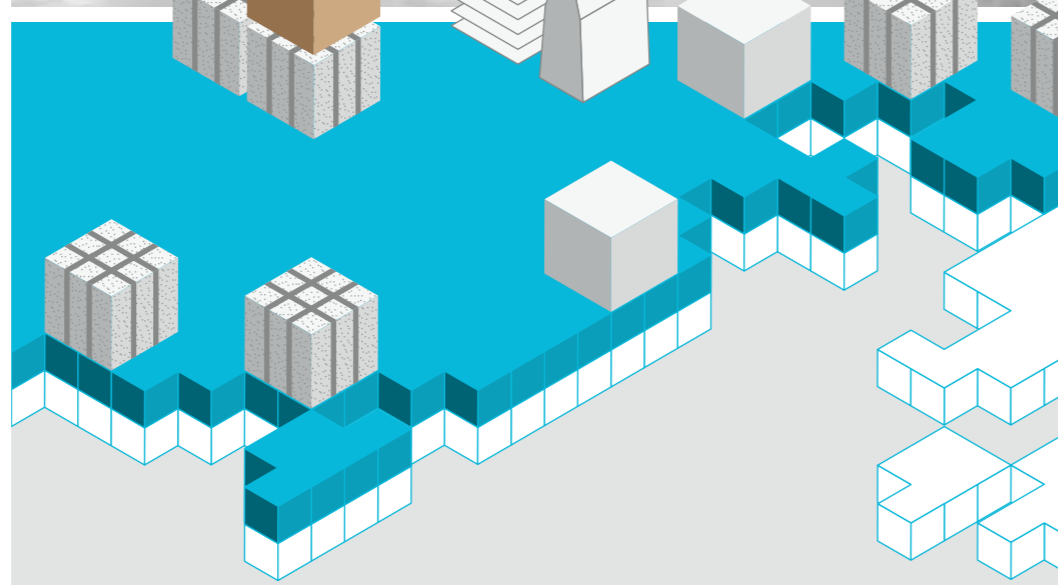

1 The PM 39 for graphic paper at Sun Paper's Yanzhou site improves efficiency and profitability.

CO₂

Carbon neutrality
by 2060



↓ 10 - 15

percent less energy consumption
with the BlueLine OCC
process at Shanying Paper

As all six of the BlueLine OCC stock preparation units are structured identically, the setup bringing additional efficiencies for Nine Dragons Paper. "Having a standardized production process across numerous sites enables a more streamlined inventory of spare parts and consumables," highlights Tony Liu, Sales Manager at Voith. "It also means that we can implement tried-and-tested successful processes across locations. That's a huge advantage for creating long-term efficiencies."

Shanying Paper: a competitive edge

The common fear that greener policies will lead to additional costs does not ring true, as two projects for Shanying Paper clearly demonstrate. In fact, the calculated savings in energy consumption was a key argument for the first project, the BlueLine OCC stock preparation for the company's new PM 21 at the Shanying Paper facility in Hubei. Compared to its closest competitors, Shanying Paper now consumes between 10 and 15 percent less energy. Clearly, such a reduction has a financial upside. As a result of the resource-efficient Voith stock preparation, Shanying Paper saves around 10 million Yuan (1.3 million euros) each year.

"For Shanying Paper, our concept not only ensures a more sustainable production process, but it also brings compelling economic benefits," highlights Senior Project Manager William Wang, who supervised the project for Voith at the Shanying Paper facility in Hubei. Completed in December 2019, the site can process up to 1,600 tons of raw materials per day, and, thanks to the BlueLine stock preparation unit, it does so with a reduction of fiber loss by 0.5 percent.

The company's second successful start-up took place in May 2020. PM 22 has benefited from Voith's expertise as a full-line supplier.

As well as the complete XcellLine paper machine, Voith also supplied the entire BlueLine OCC stock preparation line, including the pulping drum IntensaDrum and InfiltraDiscfilters that are important for efficiency and sustainability.

The positive environmental and economic impact of this project is already evident, as Zejun Weng, Vice President of Operations at Shanying Paper confirms: "PM 22, however, is the best among all our sites in water consumption, electricity and energy consumption. It achieved the target goal in short time also helped in reducing the whole operation cost."

Sun Paper: passionate teams

"Sustainable papermaking needs to be viewed with a holistic perspective and a future-oriented strategy in mind," explains Kurt Yu. "To be in a position to help our customers with their goals, we build long-term partnerships." One such partnership is with Sun Paper, the largest privately owned paper manufacturer in China, who has chosen to work closely with Voith since the company entered the paper packaging business back in 2014. It is also the reason why Sun Paper absolutely trusts Voith expertise for its "Going Global" expansion strategy in Southeast Asia and with its ongoing developments in China.



↓ 0.5

percent less fiber losses with
the BlueLine OCC
process at
Nine Dragons Paper

Voith's first specialty paper machine in China
Sun Paper PM 40

1

From a sustainability perspective, the fourth Sun Paper project is perhaps the most intriguing of them all. With a view to producing environmentally friendlier MG paper that serves as a new trend in the transformation and upgrading of the packaging industry, Voith has developed a customized specialty paper machine for Sun Paper's Yanzhou site, the PM 40. The machine sets a standard for efficient and stable production of green paper. At the core is the MG cylinder with a diameter of 6.1 meters, a key component for the production of machine glazed paper that is reusable, recyclable and degradable. With a paper width of 4,800 mm and a design speed of 800 m/min, PM 40 will produce MG paper with a basis weight range of 25 to 80 g/m².

Hongxin Li, Chairman of Sun Paper, sums up the company's successful partnership with Voith: "We are cooperating with a passionate team. Voith is customer-oriented and highly dedicated to the work involved. We are impressed by the high efficiency of Voith's project execution and we are looking forward to greater achievements by working closely together."

Bohui Paper: bigger, but greener

Large-scale operations can be customized to be considerably more sustainable, as the BM 4 for Bohui Paper shows. In operation at the company's Dafeng mill in Jiangsu province since 2018, the largest board machine in the world is fitted with Voith innovative technology that precisely targets energy consumption. In fact, for this plant, Voith supplied the complete paper machine, from approach flow system to reel section. At a speed of 1,200 m/min, the BM 4 produces paper for folded box board with basis weights of up to 300 g/m².

Most notably, one of the special features of the BM 4 is the TurboDryer S in the dryer section. Not only does it improve runability and increase production by up to five percent, it also reduces energy consumption. Thanks to the TurboDryer S, energy consumption can be tailored precisely to the paper grade in production. As a result, only as much energy is consumed for hot air drying as is actually necessary. In addition, the drying section is also equipped with qDry Pro, a drying concept that combines infrared and air drying. Compared to older systems, this combination ensures a 40 percent increase in energy efficiency coupled with lower investment and operating costs.

Four of the most recent projects draw on Voith's expertise across a number of paper grades, from corrugated board to specialty paper. In Laos, for instance, in a significant milestone for Sun Paper, Voith ensured the fast start-up of two XcelLine packaging paper machines, PM 1 and PM 2, within quick succession, despite the most difficult of working conditions during the COVID-19 lockdown. PM 1 works in a basis weight range of 140 to 250 g/m² and is set to produce 520,000 tons per year. The PM 2 focuses on lower basis weights of between 100 and 160 g/m². The planned annual production capacity is 480,000 tons.

"We are very proud that PM 1 started up ahead of schedule with joint efforts from both parties," says Aiming Zhang, Laos Project Director from Sun Paper. The start-up of PM 2 took place within one month of PM 1, again ahead of schedule. "This success proves again the expertise and know-how of both teams, as well as the close collaboration. I believe that PM 2 will soon achieve the highest performance level."

Back in China, the Voith-Sun Paper partnership has reached new levels. First, the start-up of the XcelLine graphic paper machine PM 39 at the Yanzhou site in Shangdong province went smoothly, again despite COVID-19 restrictions in place. "PM 39 is accelerating the shift in company structure optimization, supporting the enrichment of the product category and bringing in higher efficiency and profit," says Wenchun Wu, Director of Graphic Paper Business Line of Sun Paper. "Working closely, Sun Paper and Voith have conquered many challenges to realize the successful start-up, even ahead of schedule."

1 million

tons of production capacity at Sun Paper in Laos



↑ 40

percent more energy efficient drying Bohui Paper BM 4



1



2

Shortly after the BM 4, a second machine supplied by Voith went into operation for Bohui Paper: the BM 5. Both are the result of a long-standing and successful collaboration between Voith and Bohui Paper and follow the smooth and timely construction and commissioning of the BM 1 in 2003 and the BM 3 in 2013. Initially, the BM 5 was intended to produce plasterboard, a small market for Asia. However, thanks to the extensive flexibility of the machine, the company has increasingly been using the BM 5 for testliner, with basis weights of 100 g/m² and above. "Thanks to our close collaboration, we can engineer the BM 5 according to the specific needs of Bohui Paper," says Wenjie Jiang, Senior Sales Manager at Voith. "Our technology is so flexible that Bohui Paper is now planning to adapt this production line to manufacture flexible packaging paper designed for various applications. Whatever the paper grade, what we hear from Bohui Paper is how efficient the production is on all of our machines."

As the Voith experience in China has shown, the demand for paper continues to grow, and the market is by no means saturated. However, the challenge will be to balance that growth with achieving the country's ambitious goal of carbon neutrality in only 40 years' time. At Voith, we are committed to supporting our partners with technologies that target energy and water consumption and also enable the efficient processing of recovered paper fibers. "Our innovations ensure the best performance of our machines, even in the most basic of modules," concludes Kurt Yu, Regional President Voith Paper Asia. Beyond that, optional components and digital technologies provide increased sustainability. AquaLine Zero, for instance, targets water consumption and also allows a closed water circuit at production plants. It's the ultimate add-on for efficient paper production. It supports the conservation of resources and will meet the increasingly stringent environmental requirements of the future. And not just in Asia.

- 1 With PM 1 and PM 2, Sun Paper is expanding its market presence in Southeast Asia.
- 2 Proven partnership even before the pandemic: Sun Paper has a total of eleven paper machines from Voith in operation.

An extra layer in

Oxygen barrier
A barrier against oxygen keeps food items fresh longer and makes them durable.



Grease barrier
Grease-proof paper protects and packages grease-containing products.



Water vapor barrier
The barrier effect against water vapor protects the product from moisture and increases the dimensional stability of the paper.



Sustainability – Sustainability!

of 12 million tons of plastic waste p in the world's oceans each year. atens humans as much as it does rine animals and birds – because micro particles via the fish we eat ne desalinated water we drink, for The United Nations (UN), environal groups and consumer associa- advocating for a reduction in the f plastic and urging companies to native products instead – such as nable barrier paper. Papermakers can optimally develop these on odernized pilot coater at the Voith Technology Center.

Oxygen barrier
A barrier against oxygen keeps food items
fresh longer and makes them durable.

AN

Facts & Figures

18 19

- Modular design of the coating stations with up to 18 different coating variations
- 19 different options for web run
- New compact DynaLayer station for simultaneously applying up to three coating layers

25-600 g/m²

- For all sized or coated grades with basis weights from around 25 to 600 g/m²
- Around 200 sensors for measuring drying-specific parameters
- Lower and upper hood of the respective dryers can be controlled separately – for each dryer

200

“We can run a wide range of coating variations for all grades of specialty paper, packaging paper, board and graphic paper on our pilot coater – and all with highly efficient drying.”



Uwe Fröhlich
Senior Manager R&D Pilot Operations at Voith

A total of 12 million tons of plastic waste ends up in the world’s oceans each year. This threatens humans as much as it does marine animals and birds – because we ingest micro particles via the fish we eat and the desalinated water we drink, for example. The United Nations (UN), environmental groups and consumer associations are advocating for a reduction in the use of plastic and urging companies to offer alternative products instead – such as sustainable barrier paper. Papermakers can optimally develop these on the modernized pilot coater at the Voith Technology Center.

Sustainable – sustainability!

8

Eight air dryers ensure careful drying of the application media and guarantee the function of the barrier layers.

Printability
Important for manufacturers: excellent printability of the barrier papers for further processing.



The number is frightening, the threat very real – at the UN conference in Nairobi in February 2021, UN Secretary-General António Guterres criticized humanity's unsustainable consumption and production systems that are devastating ecosystems. "This is suicide. Nature always strikes back." That's why four UN countries – Germany, Ghana, Ecuador and Vietnam – are now joining forces to push for a global plastic waste reduction agreement to be adopted in September.

Even all-out plastic bans are on the table. But plastic bags and drinking straws are comparatively easy to replace with equivalent paper products. When it comes to waterproof and airtight food packaging, things get more challenging. This is where barrier papers come into play as a sustainable alternative to plastic packaging. "Many food companies already rely on such paper as a flexible packaging solution," knows Frank Opletal, CTO Voith Paper. And because the market for barrier paper in general, and for coated paper in particular, is changing and growing rapidly, Voith has extensively modernized the pilot coater at its Technology Center in Heidenheim and can now meet the requirements of the new grades even better.

"If existing plastic-based packaging was simply replaced with laminated paper, we wouldn't gain much in terms of reducing plastic use and protecting the environment over the long term," says Opletal. This is because laminated papers still contain a significant amount of plastic and are more difficult to recycle. Instead, the true sustainable alternative is coated paper that can be recycled and, ideally, is biodegradable.

"We can run a wide range of coating variations for all grades of specialty paper, packaging paper, board and graphic paper on our pilot coater – and all with highly efficient drying," says Uwe Fröhlich, Senior Manager R&D Pilot Operations at Voith, alluding to the technical challenges of the coating process. This is because in addition to applying one or more functional layers to the paper, it also encompasses the equally demanding drying process – the only way to achieve a high-quality result.

"Upgrading our pilot coater has once again significantly increased its flexibility," explains Fröhlich. Thanks to the modular setup of the coating stations, the system is capable of handling a total of 18 different coating variations. For example, the two SpeedSizer AT stations can be used not only for conventional film coating but also as a size press or high-penetration SpeedSizer. In addition to the existing coating methods with the SpeedSizers mentioned above or the DynaCoat for roll or blade coating, the new DynaLayer is the most widely used option for highly functional barrier paper grades. Thanks to the compact curtain coating technology, up to three layers can be applied at the same time.

Another important factor in the production of barrier paper – but also many other types of coated paper – is careful and precise drying. Over-drying carries the risk of bubbles formed in the coating layer, which would destroy the barrier properties. Under-drying, on the other hand, can also cause defects, especially if the coating layer has not yet completely dried when the paper passes through subsequent guide rolls. This is why the pilot coater is equipped with around 200 sensors for measuring drying-specific parameters and innovative automation technology that opens up a wide range of analysis and process control options. "As part of the upgrade, we succeeded in implementing non-contact drying in the existing hall over a web length of more than 40 meters," explains Fröhlich. Eight dryers, the last of which can also be used as a cooler, ensure that the coating is dried reliably. What makes the pilot coater unique is that the dryer hoods at the top and bottom can be heated separately depending on the requirements. "The optimized and expanded drying capacities are a significant advantage, especially for the production of barrier paper, because the flexible design of the drying line allows the trials to be carried out at real production speeds, thereby ensuring that the results can be optimally applied to actual production situations," says Fröhlich.

In order to also include upstream or downstream process steps in the trials, the pilot coater can be combined with the XCal1 pilot calender. This makes it possible, for example, to specifically investigate the impact of precalendering on barrier properties.

In addition, customers can test the recyclability of the developed papers directly at Voith's Fiber Technology Center. After all, the environment only benefits if the product is recyclable. "The first customers have already inquired about conducting such trials," Fröhlich is pleased to report.

4evergreen alliance



Voith recently joined 4evergreen, an alliance of over 60 companies along the entire packaging paper value chain. The members' common aim is to raise the overall recycling rate of fiber-based packaging to 90% by 2030.

2030

A recycling rate for fiber-based packaging of over 90% by 2030 – that is the goal of the 4evergreen alliance, of which Voith is a member.



Recyclability
Sustainable barrier papers must be recyclable and biodegradable.

Sustainable paper production needs a sustainable water management strategy. AquaLine, AquaLine Flex and AquaLine Zero are making this possible.

Mission Zero

AquaLine Zero

Amount of fresh water is reduced

The amount of fresh water required is 1.5 l/kg of paper produced – exactly the amount that evaporates during paper production.

No process effluent

The closed water loop sets the process effluent volume to 0 l/kg of paper produced.

Roughly **10%** reduction in carbon dioxide emissions

AquaLine Zero: Closed water loops reduce the amount of process effluent volume to 0 liters/kg of paper produced. The amount of fresh water required stands at roughly 1.5 liters/kg. At the same time, the system significantly reduces carbon emissions.

- 1 Stock preparation
- 2 Anaerobic stage
- 3 Wet end process & paper machine
- 4 Fresh water input

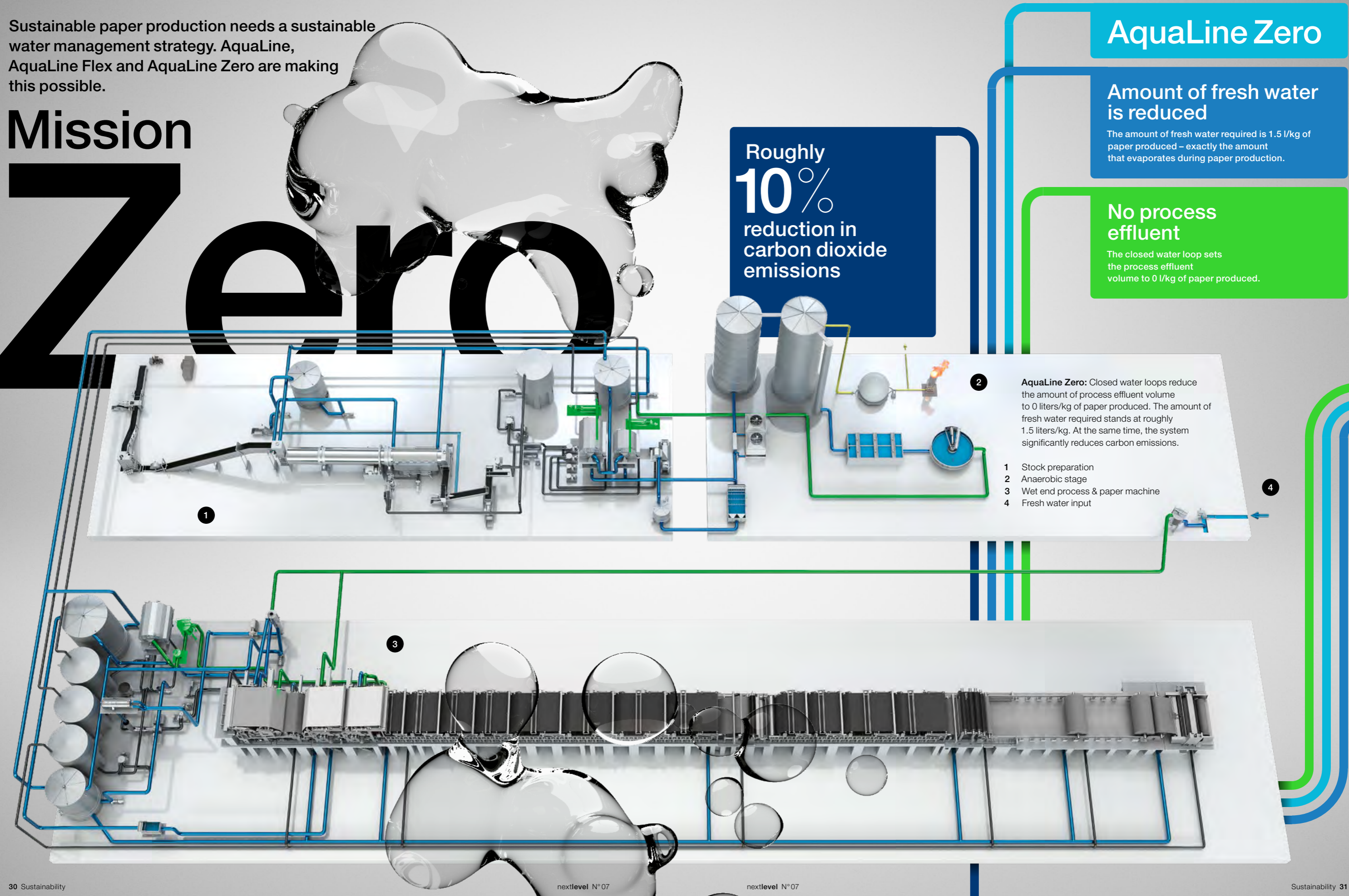

Evaluate the initial situation:

Technology solutions such as AquaLine Zero and AquaLine Flex, with which a reduction in the specific fresh water requirement and the specific process effluent volume can be achieved, require an extensive evaluation of the framework conditions with regard to production, process and environmental parameters as well as the operational environment (raw materials, chemicals, personnel) and can only be successfully implemented under suitable conditions.

AquaLine Zero

ca. **1.5** amount of fresh water l/kg paper

0 process effluent volume l/kg paper

AquaLine Flex

< 5.5 amount of fresh water l/kg paper

< 4.0 process effluent volume l/kg paper

AquaLine

> 5.5 to 7.0 amount of fresh water l/kg paper

> 4.0 to 5.5 process effluent volume l/kg paper

AquaLine Flex and AquaLine: With AquaLine Flex, the amount of process effluent volume is reduced from roughly 5.5 l/kg of paper produced to roughly 4 l/kg. The amount of fresh water required is around 5.5 l/kg – with AquaLine it is approximately 7 l/kg.

Paper mill operators at many locations around the world are facing more stringent regulations and water rights. AquaLine Flex and AquaLine Zero are two water management concepts from Voith that not only meet stricter environmental requirements, but also make sustainable packaging paper production possible thanks to saving a tremendous amount of fresh water and primary energy.

AquaLine Zero Lowers Process Effluent Volume to Zero Liters

At Voith, AquaLine stands for sustainable water management. Because, after all, the combination of a biological purification plant and filter systems, both of which are being developed by Voith and the expert team at Meri Environmental Solutions GmbH, can reduce fresh water consumption. But the technology group is not satisfied with this alone – with AquaLine Zero, Voith is going one step further. “With this solution, we are taking a clear step in the direction of sustainability and decarbonization. This is because we are closing the water loops and reducing carbon emissions at the same time,” says Eckhard Gutmuths, Product Manager Low Effluent Mill at Voith.

In the case of AquaLine Zero, this specifically means that as a result of closed water loops,



“With AquaLine Zero, we are taking a clear step in the direction of sustainability and decarbonization.”

Eckhard Gutmuths
Product Manager
Low Effluent Mill
at Voith

no treated process water of any kind is discharged from the packaging paper mill. Instead, all of the process water is filtered and purified and then returned to the production cycle in place of fresh water. This reduces the actual amount of fresh water consumed per kilogram of paper produced to only about 1.5 liters – exactly the amount that evaporates during the production process. In comparison, a conventional packaging paper mill consumes around 7 liters of fresh water per kilogram of paper produced. At the same time, the equivalent of about 5.5 liters/kilogram of paper produced is discharged as process effluent volume. This is usually pre-cleaned within the paper mill before discharge.

From a technical perspective, this significant increase in sustainability is made possible thanks to two components. On the one hand, the biological purification system is operated exclusively with an anaerobic process stage, known as the “biological kidney,” and a LimeTrap decalcifier. The process water is treated in such a way so that 100 percent of it can be returned to the production cycle. On the other hand, Conustrenner and Gyrosand filters in the paper machine further process the water from the filtrate of the disc filters in order to be able to use it in place of fresh water at various spray pipes in the wet end of the paper

machine. But that is not all – the larger, anaerobically treated effluent stream also produces a large amount of biogas. This can be used to reduce primary energy consumption at the paper mill. AquaLine Zero achieved a roughly 10 percent reduction in carbon dioxide emissions in a packaging paper line that has already been successfully brought into operation. The concept for such a plant is developed within Voith and with Meri Environmental Solutions GmbH, and closely coordinated with the customer.

Achieving Greater Sustainability and Flexibility with AquaLine Flex

As the name suggests, AquaLine Flex enables packaging paper machine operators to modernize an existing line or equip new lines in an extremely flexible manner. This is because, when planning to expand production facilities, it is not uncommon for the official requirements to have changed over time or for there to be stipulations in place regarding permissible process effluent quantities. In contrast with conventional systems, AquaLine Flex reduces this amount from an average of 5.5 liters to around 4 liters/kilogram of paper produced. At the same time, it also reduces the amount of fresh water required from around 7 to about 5.5 liters/kilogram of paper produced.



“Our technology and our know-how for integrated systems maximize resource savings.”

Henning Laubrock
Head of
Sales & Technology
at Meri

This is made possible by treating the process water through anaerobic and aerobic biological purification stages, some of which can then be reintroduced into the production process after purification. AquaLine Flex also features Conustrenner and Gyrosand filters, which make it possible to use treated process water instead of the fresh water required in the wet end of the paper machine. As a result, the AquaLine Flex system is perfect for paper mills where water availability is limited or which want to significantly reduce their fresh water and process effluent costs.

Numerous Experts on the Job

Through its AquaLine Zero and AquaLine Flex solutions, Voith makes the key to successful and sustainable water management clear: “It is the combination of high-tech expertise, innovative products, automation processes, and the conceptual planning and implementation of complete factory layouts,” says Eckhard Gutmuths. Voith and Meri have numerous engineering experts worldwide who use their knowledge and experience to plan and build sustainable paper mills. In this process, operators receive 3D plans as a decision-making tool as well as a modern industrial design that takes all of the relevant operating and safety aspects into account.

It doesn't always have to be a new machine – by refurbishing certain components of a line, paper manufacturers can cost-effectively optimize processes and achieve sustainability goals.

Due to a change in market requirements, a South American tissue paper manufacturer has adjusted the basis weight on its machine. At the same time, this led to a change in the vacuum system demand. The company decided to have the local Voith Service Center in Concepción, Chile, measure the performance of the vacuum pumps. And the decision paid off. "Based on the results, the customer made some technical adjustments to its system, had four pumps refurbished and optimized its process, particularly in terms of energy consumption," says Geert Tichler, Senior Product Manager Refurbishment Technologies at Voith. This is just one of numerous successful examples that Tichler can cite. Also worth mentioning are successful projects in Southeast Asia, where Voith overhauled vacuum pumps for various customers and received a maintenance contract for a total of eight vacuum pumps, including the delivery of a new pump, from one of the largest paper manufacturers.

In early 2021, the Voith Service Center in São Paulo, Brazil, was also commissioned with a maintenance contract for 10 vacuum pumps. And Tichler knows: "A vacuum pump can usually operate efficiently for several decades if it is inspected every ten years and refurbished as necessary. So it's no surprise that papermakers happily take advantage of our services to make their production processes more efficient and sustainable." A refurbishment usually only forms a small part of a comprehensive maintenance service package.

Each refurbishment project starts by precisely measuring performance on site, while the line is in operation. During this performance review, Voith specialists measure each pump's vacuum level and air flow rate, among other parameters. Voith then recommends refurbishment or replacement measures on the basis of this analysis. After performing these measures, the performance of the pump in operation is measured once again. This allows papermakers to see exactly what effect refurbishment has on the productivity of their line.

Exemplary refurbishment of the rotor of a vacuum pump

Condition before the repair
The rotor made of cast steel rotor is heavily worn.



Restoration of the geometry by welding
With the technical expertise of experienced employees, the rotor is refurbished



Condition after mechanical machining
As an OEM manufacturer, Voith reworks the rotor with absolute accuracy.



Refurbishment completed
The rotor was provided with a wear- and corrosion-resistant coating and balanced.

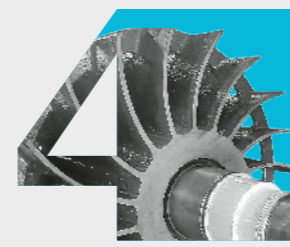

Other examples of refurbishment services include disc filters and screw presses. Similar to vacuum pumps, Voith refurbishes them regardless of manufacturer, size and model. Refurbishing disc filters, for example, involves repairing the center shaft. A defective or worn out center shaft prevents the desired vacuum from being achieved, which in turn results in incompletely filled segments and also reduces the quantity and quality of the filtrate – and therefore the productivity of the entire system. Refurbishing the center shaft solves this problem, which is accomplished by restoring its geometry by welding or metallization. The sealing surfaces are then subsequently grinded flat again. Papermakers would be well advised to test the performance of the disc filters every 10 years as well. In contrast, the productivity of screw presses should be checked every one to two years. If refurbishment is necessary, the flights of the screw press can be refurbished and sharpened again during scheduled machine downtime. In this context, Voith uses a tool developed especially for this purpose: the SmartGrinder. This tool precisely follows the geometry of the blade during the grinding, making it possible to reduce downtime by up to 20 percent compared to conventional repairs.

Voith also offers upgrade services for the CSM12/12B and CSM22/22B CombiSorter. The inner lining in the lower housing of the CombiSorter often wears out at an above-average rate due to heavy particles during the separation of contaminants and fibers. This increases fiber loss, which in turn increases production costs for paper manufacturers. To counteract this, Voith has developed a special wear-resistant lining made of a cast steel alloy to replace the standard lining, which is usually made of basalt. Voith's solution has been officially available since 2018. Before that, it underwent extensive testing: "Our tests have shown that the cast steel lining will last at least five years, depending on the operating conditions," explains Tichler, adding, "a basalt lining, in contrast, usually only lasts a year." After a one-time modification of the housing at one of Voith's worldwide Service Centers, the lining can even be replaced on site.

In Oudegem, Belgium, VPK Packaging eagerly takes advantage of this service. The company had the chance to be one of the first to test the new lining a few years ago. For this purpose, the manufacturer had the basalt lining of a CombiSorter replaced with Voith's new lining. When it was removed again for analysis three years later, it still looked as good as new. Thanks to the refurbishment, the CombiSorter is as productive as it was right after it was initially brought into service, reports VPK Packaging's highly satisfied engineer in charge. The results impressed the company so much, in fact, that it decided to have four more CombiSorters gradually refurbished by Voith's experts in Vaassen, the Netherlands.

Schematic illustration of a vacuum pump

- 1 Housing
- 2 Cover
- 3 Rotor
- 4 Control head

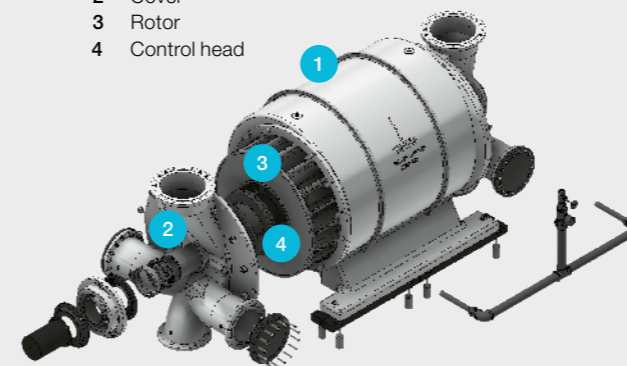

Keeping Customers' Processes

Customized Total Roll Management maximizes availability and performance irrespective of the manufacturer. Comprehensive cost transparency and proximity to the customer are further factors that contribute to the success of this service offering.

As part of the TRM, all components are examined in detail for wear and damage.

It's hard not to be impressed by Voith's facility for roll services in Kunshan, China. Anyone entering the hall is greeted by the world's largest and most state-of-the-art roll test rig. As part of Voith's Total Roll Management (TRM) program, customers can have comprehensive troubleshooting and root cause analyses carried out there for rolls with a maximum diameter of 2,500 mm, a total length of up to 15,000 mm, and at test speeds of up to 2,500 m/min – for every type of roll with every cover from every manufacturer. In addition to dynamic vibration measurements, the range of services also includes measuring oil flow for gears and pressure zones as well as documenting the temperature profile of individual roll components. "Our roll services draw on all of the experience we've gained over more than 150 years of mechanical engineering," says Thomas Zhang, Senior Technical Sales Manager at Voith, proudly. "In this context, being close to customers plays a key role." As a result, each of the 23 worldwide locations where Voith offers TRM is found in a location specifically selected to keep distances to customers short. This also applies to the two other service centers in China – Nansha in the south and Dongying in the north of the country. Over the years, both have established themselves as preferred partners for roll grinding. During operation, rolls are subject to continuous wear and have to be reconditioned at regular intervals. When grinding the rolls, the experts restore a roll surface with a precisely defined structure and roughness in order to achieve the longest possible service life. "Precise grinding lays the foundation for high system productivity," emphasizes Zhang.

In addition to physical proximity, being close to customers also means closely collaborating with them. "In addition, TRM customers receive on-site technological support for grinding, condition diagnostics and advice on replacement intervals. This allows them to accurately plan and budget for maintenance costs," Zhang explains.



Rolling

"Optimizing roll performance and the resulting increase in paper machine efficiency is another important aspect of the TRM program," emphasizes Michael Fürst, Senior Product Manager Mechanical Roll Service at Voith. Regular audits and in-depth discussions at the customer's site are indispensable and help extend the service life of the rolls, identify weak points and improve their performance.

TRM customers also benefit from the ongoing advancement of Voith's roll and service technology. For example, the service recently started using the OnCare.pmPortal with the ID Tagging module for rolls and roll covers. "This means that a comprehensive roll history is available anytime and anywhere, which helps make service measures even more efficient," explains Fürst, adding: "this takes TRM to a whole new level."

#EFFICIENT PAPERMAKING

Discover the potential of efficient papermaking.

p. 37 —————> 51

Go Digital

Next Stop: Autonomy

Fluctuations in the stock preparation process are unavoidable – and challenge Sebastian Schuster and his colleagues to continuously increase stability. Their tools in this process include sensors, units of measure, tracking systems and connectivity. The experts' vision? To create a stock preparation system that achieves defined goals without external intervention.

15–20%

higher production capacity with BaglessPlus disc filters

New development: Based on the proven BaglessPlus sectors, Voith has developed FloWing filter sectors with a patented blade geometry. The novel design allows the growth of a thick fiber mat and ensures an ideal release of the fibers.



1 BaglessPlus disc filters permanently provide excellent and uniform filtrate quality, which in turn leads to a significant reduction in fiber losses and fresh water requirements.



“Self-adjusting, autonomously operating systems are the basis for a stock preparation that works as efficiently and cost-effectively as possible.”

Sebastian Schuster
Product Manager OCC at Voith

“Today papermakers sometimes accept higher stock losses or greater energy consumption in stock preparation just to avoid downtime,” says Sebastian Schuster. The Product Manager OCC at Voith understands this perspective. After all, every minute a line is out of operation not only costs time but also money. Companies are willing to tolerate these additional costs, however, if it guarantees system run-ability. Schuster summarizes the dilemma: “Typically, process parameters are set to avoid nearly all operational problems – regardless of how often a problem occurs.” But this also challenges him and his colleagues to offer paper manufacturers a way out of this quandary. Schuster’s goal: “Self-adjusting systems that operate autonomously!”

The first steps towards such autonomous lines are already the state of the art today. Robust machines are one example, which are less sensitive to process fluctuations from one generation to the next. For Schuster, the BaglessPlus disc filters now represent a tried-and-tested example of this robustness: “Thanks to the stainless steel discs, the dewatering systems withstand process fluctuations better than the previous plastic products, thereby delivering excellent and consistent filtrate quality on an on-going basis and achieving a 15 to 20 percent increase in production capacity.”

But this traditional approach comes at a price. “At some point, you reach a point where increasing robustness is no longer cost-effective,” Schuster says. This is especially true in stock preparation, where process fluctuations are the rule. “The quality and form of the input raw materials are simply far too different. One bale of recovered paper, for example, may contain five percent impurities and a large amount of kraft-containing cardboard, while the other may contain 10 percent impurities and mixed waste paper,” explains Schuster. In order to always operate reliably, however, the line must be configured for raw materials that are particularly difficult to process – even if it only processes them on rare occasions.

In the case of BaglessPlus disc filters, torque detection is one solution already available today. In this case, if a critical increase in torque is detected due to excessive thickening, water is automatically added – preventing the discs from being bent or even destroyed. The result of this approach is an increase in system availability without the need for an operator to intervene and make adjustments.

For the IntensaMaXX, Schuster outlines a similar solution for greater efficiency: Up to now, the machine usually disposes its rejects on the basis of fixed cycles, regardless of the actual impurity and raw material content. This not only wastes resources but also causes an unnecessarily high level of wear on the valves. Schuster’s alternative: “We want the system to recognize when a critical situation is imminent and then take steps to prevent it itself.” Voith is working on a digital solution that continuously measures the motor’s load. If impurities accumulate in the machine, its power consumption increases. Rejects are only discharged when a critical threshold is exceeded –

5–10%

impurities can be contained in a bale of recovered paper

Up to now, reject discharge in the IntensaMaXX has been carried out on the basis of fixed cycles, irrespective of the actual impurity content (top). By measuring the motor load, discharge only takes place when a critical power consumption threshold has been exceeded (bottom). This reduces valve wear and stock losses.

reject discharge on basis of fixed cycles

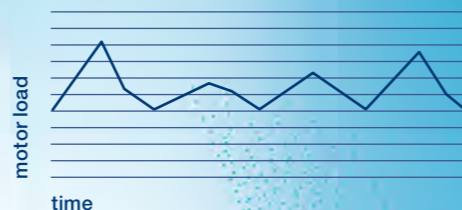

reject discharge on basis of motor load

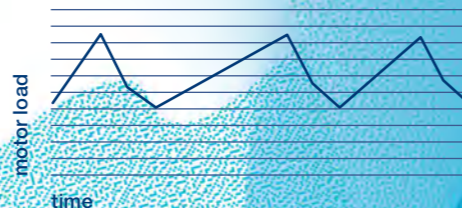

2 The Twin Pulp System with IP-R Pulper and IntensaMaXX at Schoellershammer in Germany.



eliminating the need for fixed cycles. This reduces both valve wear and the amount of maintenance required, which in turn reduces the risk of machine downtime.

Incidentally, the next step towards even more efficient reject discharge is already being tested at Voith: Optical systems on the reject stream detect whether the system is actually discharging impurities or fiber material and readjusts the corresponding parameters, if necessary. On Voith’s protector system, for example, a camera tracks particles and measures their speed and direction of movement. The data obtained in the process makes it possible to autonomously adjust the amount of water required. Fixed reject timing is replaced by variable timing controlled by the camera, which reduces valve movements – and therefore their wear. The initial results of the test installation indicate that the system can make a line more autonomous and significantly more efficient.

When it comes to fine screening, the experts are also working on a digital tool that will optimize the screening process, which is currently still carried out on the basis of the flow rate. This is because, up to now, the different quality requirements of the paper machine were rarely taken into account at this point. Schuster is surprised by this: “The requirements for an 80 g/m² corrugated medium are different from those for a test liner with 120 g/m².” Yet it is a well-known fact that there is a strong correlation between impurities and stickies. “We’re currently testing a sensor-based process concept that is capable of detecting impurities that indicate critical levels of stickies. This makes it possible to effectively adjust the screening quality depending on the requirements of the paper machine,” explains Schuster. The system then operates autonomously. The challenge lies in the fact that the system must be just as capable of reliably recognizing situations in which it can no longer find a solution on its own and needs to request operator support. Over the coming years, this will transform stock preparation, which is currently still production-controlled, into a concept that also strongly focuses on quality and efficiency. The stock preparation system will not only operate more independently but will also make the papermakers’ work much easier. They will then have the ability to always precisely adjust the quality of the stock flow and the fiber yield to the current requirements – and thereby also save energy. Finally, the system will find the best way to do this all by itself.

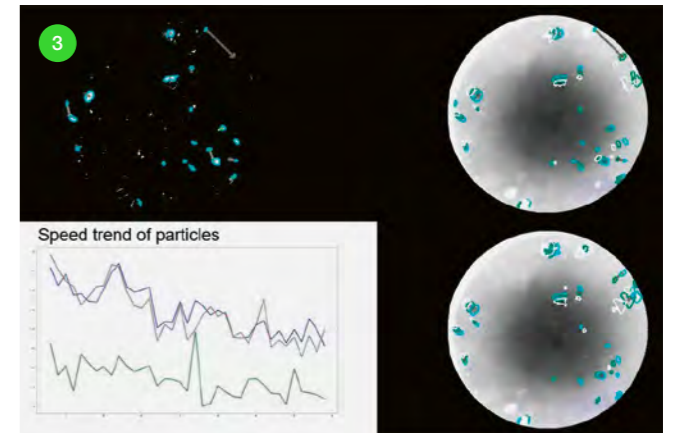

3 The amount of water required to best screen out impurities can be determined based on their particle movements. The system meters out the water autonomously. This process is based on optical systems that detect these particles in the material flow.

Important elements for an autonomous system: Reliable sensor technology (→ p. 18) and the balancing of mass flows by OnView.MassBalance (→ p. 48)



“We’re currently testing a sensor-based process concept that is capable of detecting impurities that indicate critical levels of stickies.”

Sebastian Schuster
Product Manager OCC at Voith

Full

The traffic light symbol on his tablet is bright green. By tapping on it, Karl-Josef Uhlemann receives the information relevant to him: The roll cover will last another 80 days. "Thanks to the OnCare.pmPortal, I always have the data I need at my fingertips – anytime and from anywhere," says Uhlemann enthusiastically.

Control!



Replacing

Traffic light symbols indicate when a component is due for replacement.

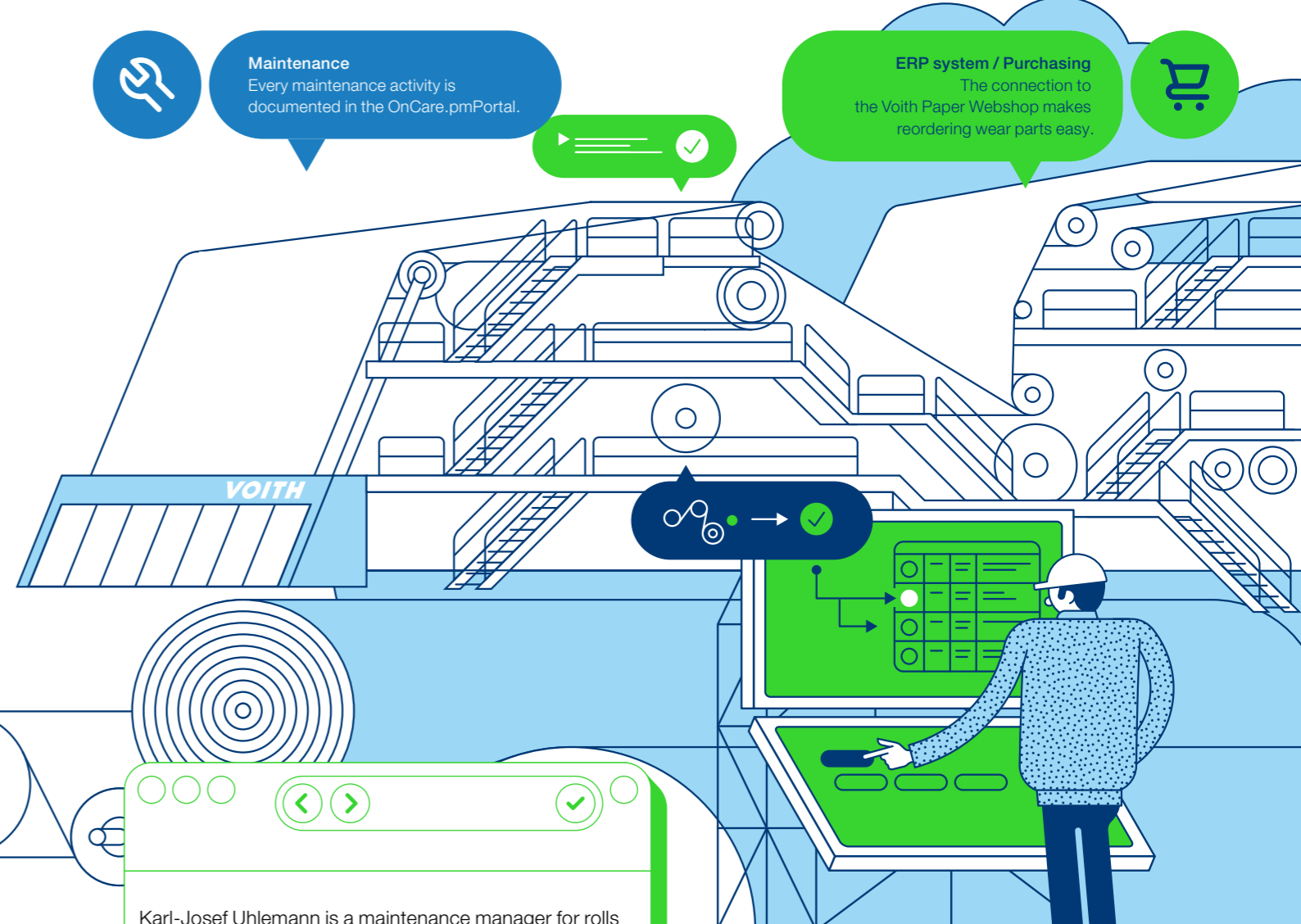

Maintenance

Every maintenance activity is documented in the OnCare.pmPortal.

ERP system / Purchasing

The connection to the Voith Paper Webshop makes reordering wear parts easy.

Karl-Josef Uhlemann is a maintenance manager for rolls at Schoellershammer in Düren. Every day, he coordinates maintenance measures and oversees numerous processes. During his day-to-day work, an asset management tool not only helps him manage the inventory, but at the same time provides him with information about the condition of the products as well as their remaining service lives. It also allows him to reorder components conveniently and securely. Voith's OnCare.pmPortal does all of this – and more. What has so far been possible for fabrics, rolls, roll covers and doctor blades will soon also be possible for rotors and screen baskets.

"The OnCare.pmPortal gives me a graphical overview of the individual sections of the paper machine, and I can click on the position of each roll and fabric via color-coded hotspots," says Uhlemann. Clicking on these reveals a wealth of useful information such as product specifications, installation date, and remaining service life. The latter is displayed via a traffic light symbol. If it is red, the user needs to take immediate action – such as replacing a roll or renewing a fabric. "The portal shows us the consumables and assets installed in the system at a glance, as well as their product number or name and

their current status. In addition, I can access an overview of the fabrics, rolls and doctor blades we have in stock at any time, if necessary. That's a big help," says the maintenance manager. The system can be used both on a desktop computer and via a smartphone or tablet.

Another feature of the OnCare.pmPortal that Uhlemann uses regularly is the Shutdown Planning functionality, which allows him to safely and easily plan this complex process. "To do this, I enter the planned shutdown date in the OnCare.pmPortal. The system then creates a list of products in the machine that needs to be replaced at the scheduled time." It is now up to the maintenance manager to select the products from the list of suggestions that will actually be replaced during the planned shutdown. "In this case, the OnCare.pmPortal

thinks one step ahead. From this list, I can, for example, run a stock inquiry for the rolls I need and find out whether we have a replacement roll in stock for that position,” says Uhlemann. In the case of fabrics and doctor blades, an order can even be placed directly via the Voith Paper Webshop.

Data transparency, ensuring that employees have the same level of knowledge, the ability to rapidly identify products, and as a result, maximizing system availability – to Richard Birkhold, Global Product Manager Asset Management at Voith, these are also the factors that offer customers real added value through the OnCare.pmPortal. “In the past, machine operators weren’t always guaranteed to have the same level of knowledge about certain wear parts as, for example, production managers or the Purchasing department,” says Birkhold. What is the current job status of a roll or fabric? What are their specific remaining service lives? Are the individual rolls and fabrics exhibiting any anomalies? “The OnCare.pmPortal provides answers to questions like these and more,” says Birkhold. The Blade Inventory Management System (BIMS) module, for example, eliminates the need for users to spend time ordering blades, monitoring stock levels, and managing supply chains. This is all made possible by an ID tag on the packaging. As soon as an individually defined minimum stock level has been reached, the system automatically triggers an order to replenish and deliver the required doctor blades. “The customer’s blade inventory is automatically updated in the OnCare.pmPortal and can be accessed there at any time. Digitalizing this information maximizes transparency and reduces the time and effort involved in inventory management,” Birkhold adds.

“The OnCare.pmPortal shows us the consumables and assets installed in the system at a glance.”

Karl-Josef Uhlemann
Maintenance Manager for Rolls at Schoellershammer in Düren

Planning
Digital inventory management facilitates the planning of shutdowns and maintenance operations.

ID Tagging
Tags on consumables enable identification, lifecycle tracking and inventory management.

Services Also Available For Rotors and Screen Baskets

Voith continues to expand the OnCare.pmPortal. Currently, the tool can be used to conveniently manage fabrics, rolls, roll covers and doctor blades. In the future, this will also be possible for rotors and screen baskets. “The next step is extending the tool to cover stock preparation, and in conjunction with this, integrating SmartBasket into the OnCare.pmPortal,” says Birkhold. At the same time, his team is working on both linking the system to other Voith solutions such as OnCare.Asset as well as developing interfaces to external ERP systems.

Returning to Schoellershammer in Düren, where the paper machine is currently shut down for “planned downtime,” as Karl-Josef Uhlemann describes it. He coordinates the process of replacing different rolls, pointing out another advantage of the tool: “Once a roll has been replaced, the diameter of the new roll has to be entered into the machine control system. Voith already provides this important data to me via the OnCare.pmPortal, and I can pass it on to the person responsible at the machine control system.” Uhlemann pulls his smartphone out of his pocket and scans the ID tag of the replaced roll using the mobile version of the OnCare.pmPortal. “The data related to the removal and performance of the old roll during its lifetime is now transferred directly to the OnCare.pmPortal, as is the data from the new roll we just installed,” says the maintenance manager, scanning it as well. Uhlemann can use the app to access all of the product data, known as VIP data, at any time and from any location. In this case, VIP stands for “very important parameters.” And this also works offline in the event that the phone doesn’t have a data connection at a certain location inside the paper mill. “The app logs all the changes made offline, saves them, and updates them in the OnCare.pmPortal as soon as an internet connection is available again.”

The planned shutdown is now complete. All the data has been saved to the tool, and the maintenance manager has transmitted the new roll diameters to the machine control system. Karl-Josef Uhlemann is extremely satisfied: “In my opinion, the OnCare.pmPortal and ID tagging are absolutely crucial tools that help both increase data transparency at any time and from any location as well as make professional maintenance management possible.”

The central Italian town of Fabriano boasts one of Europe's longest papermaking traditions. The small town in the Marche region, where handmade paper has been produced for centuries, is now where Fedrigoni, Italy's largest fine paper manufacturer, is launching its digitalization efforts.

Data-driven

In the heart of the old town of Fabriano, visitors to the Museo della Carta e della Filigrana can learn about Italy's seven-hundred-year history of papermaking in great detail. From there, you only need to travel a few kilometers to get a glimpse of the real future of paper production. Here, at its location in Fabriano, papermaker Fedrigoni is starting a new chapter in the history of paper manufacturing and going all in on digitalization. "Digitalization plays a major role in driving improvements across all areas of our operations, including customer service, efficiency and flexibility," says Mario Naldini, COO Business Unit Paper & Security at Fedrigoni.

Bain & Company, one of the most reputable consulting firms for operations excellence in the paper industry, was given the task to help to improve Fedrigoni's entire value chain. A focus was on digitizing the paper production process. Voith was awarded the contract for implementation. "Voith put the cost-effectiveness and feasibility of the digital solutions as a priority, and that was in line with Fedrigoni's needs," says Andrea Isabella, Partner and Director at Bain & Company, explaining the decision. "In addition, we believe Voith, with its extensive technological knowledge, is at the edge when it comes to digitization in paper manufacturing."

Those responsible chose the historic papermaking location of Fabriano as the starting point for the new chapter. They identified one of paper's primary quality characteristics – its thickness – as a key factor in the implementation of the

Live data from the paper machine in Fabriano formed the basis for the advanced process control.

digitization strategy. This parameter is now monitored digitally via virtual sensors. Based on the data obtained in this process, the OnEfficiency.Strength advanced process control calculates the ideal set points for the actuators for basis weight and filler, thereby ensuring that the desired paper thickness is achieved as cost-effectively as possible.

Logging the process, laboratory and quality data over a period of three months was the first step of the project in Fabriano. OnCumulus, Voith's IIoT platform, played an instrumental role in this process by providing rapid access to

Central paper mill from Fabriano, 1926

Optimize

to achieve target quality at lowest cost

is absolutely key to the success of a digitization project. The only way to directly influence – i.e., control – the ongoing process is to use live data. For example, OnEfficiency.Strength uses live data to eliminate one of the main risks when optimizing quality: time. This is not possible with conventional methods, many quality parameters are determined in laboratory tests at the end of the production run, which takes between 30 minutes and an hour. In the meantime, the machine is more or less operated blindly.

"It's a bit too late," Fernando Carroquino, Industrial Director at OnEfficiency.Strength Paper, also warns. The manufacturer of paper made from recycled paper has systematically optimized its lines in the northern French town of Valenciennes over the past years as part of its "Digital Fiber" project, and is now taking this out to its site in El Burgo, Spain.

"OnEfficiency.Strength gives us the ability to instantly know if there is a problem before taking a sample from the reel. This is a major step forward for us in the direction of more efficient processes," explains Carroquino. One of the main benefits of digitization: "Beyond the new tools in Valenciennes, we were highly confident we would have to feed the key parameters into the system, but now the system is starting to tell us what meters need to be adjusted."

Whether in Valenciennes, France, or Fabriano, Italy, whether for standard or fine paper, OnEfficiency.Strength is achieving impressive results. "Our investment paid for itself almost immediately. Beyond this financial benefit, we have built a 'digital muscle' built on the integration of interdisciplinary competencies to scale this specific application and use the most innovative digital technologies in our operations," concludes Fedrigoni's CEO. "The significant cost savings have convinced us to use Voith's digitization expertise for further

The central Italian town of Fabriano is launching its digitalization

Data



In the heart of the old town of Fabriano, visi della Carta e della Filigrana can learn about I dred-year history of papermaking in great c you only need to travel a few kilometers to of the real future of paper production. Here Fabriano, papermaker Fedrigoni is starting in the history of paper manufacturing and g talization. "Digitalization plays a major role provements across all areas of our operatio tomer service, efficiency and flexibility," say COO Business Unit Paper & Security at Fed

Bain & Company, one of the most reput firms for operations excellence in the paper en the task to help to improve Fedrigoni's er A focus was on digitizing the paper product was awarded the contract for implementati the cost-effectiveness and feasibility of the as a priority, and that was in line with Fedrig Andrea Isabella, Partner and Director at Bai explaining the decision. "In addition, we be its extensive technological knowledge, is at comes to digitization in paper manufacturir

Those responsible chose the historic p tion of Fabriano as the starting point for the They identified one of paper's primary qualiti its thickness – as a key factor in the implem

Converting existing data into information is the central key to digitization.

IIoT

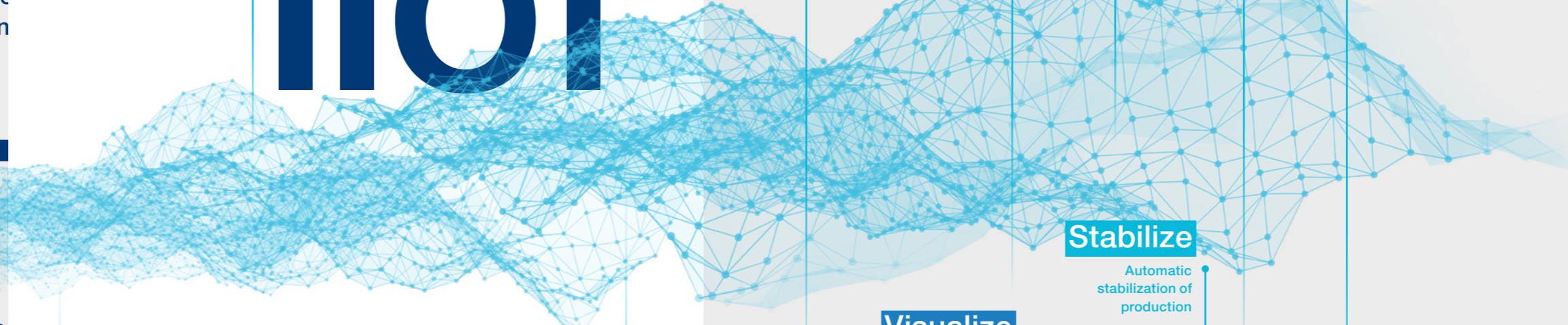

OnEfficiency.Strength makes it possible to know the paper quality even before a sample is taken at the reel.

Stable process quality, lower costs

OnEfficiency.Strength combines virtual sensors, a model predictive control (MPC), and a cost optimizer into an advanced process control (APC). The virtual sensors precisely predict quality values and enable the MPC to control the process so that the parameters are continuously achieved. The cost optimizer also ensures that this is done at the lowest possible cost.

ROI < 1 year

"Our investment paid for itself in less than a year. Beyond this financial benefit, we have also created a 'digital muscle' to scale this specific application to other lines."

Mario Naldini
COO Business Unit Paper & Security at Fedrigoni

Visualize

Detect and display fluctuations in the process corridor

Stabilize

Automatic stabilization of production

Optimize

Reliable achievement of target quality at lowest cost

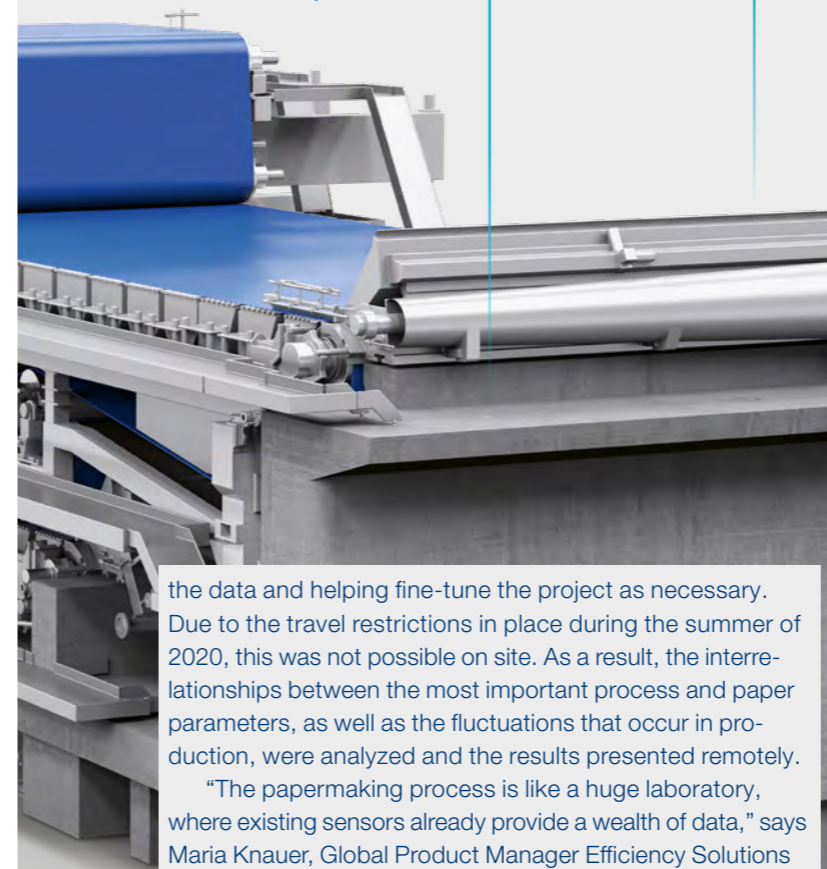

the data and helping fine-tune the project as necessary. Due to the travel restrictions in place during the summer of 2020, this was not possible on site. As a result, the interrelationships between the most important process and paper parameters, as well as the fluctuations that occur in production, were analyzed and the results presented remotely.

"The papermaking process is like a huge laboratory, where existing sensors already provide a wealth of data," says Maria Knauer, Global Product Manager Efficiency Solutions at Voith, adding, "you just need to know how to leverage them and transform them into actionable information." For example, virtual sensors can be generated on the basis of existing data, making it possible to accurately predict current values of important quality parameters at any time. And although Fedrigoni's machine is not from Voith, it was nevertheless possible to use its live data to determine a digital control strategy and implement it smoothly.

Live data is absolutely key to the success of a digitization strategy, because the only way to directly influence – i.e., optimize – an ongoing process is to use live data. For example, OnEfficiency.Strength uses live data to eliminate one of the main problems when optimizing quality: time. This is because with conventional methods, many quality parameters can only be determined in laboratory tests at the end of each tambour – which takes between 30 minutes and an hour. During this time, the machine is more or less operated in blind flight, so to speak.

"This is much too late," Fernando Carroquino, Industrial Director at Saica Paper, also warns. The manufacturer of corrugated board made from recycled paper has systematically digitized one of its lines in the northern French town of Venizel in recent years as part of its "Digital Fiber" project, and is now rolling this out to its site in El Burgo, Spain. "OnEfficiency.Strength gives us the ability to instantly know the paper quality before taking a sample from the reel. This represents a major step forward for us in the direction of more stable and efficient processes," explains Carroquino. He, too, is convinced of the benefits of digitization: "Before we introduced the new tools in Venizel, we were highly skeptical. We thought we would have to feed the key parameters into the system, but now the system is starting to tell us which parameters need to be adjusted."

Whether in Venizel, France, or Fabriano, Italy, whether for corrugated board or fine paper, OnEfficiency.Strength produces impressive results. "Our investment paid for itself in less than a year. Beyond this financial benefit, we have also created a 'digital muscle' built on the integration of internal and external competencies to scale this specific application to other lines and use the most innovative digital technologies throughout our operations," concludes Fedrigoni's Naldini. In fact, the significant cost savings have convinced the customer to use Voith's digitization expertise for further machines as well.

Creating

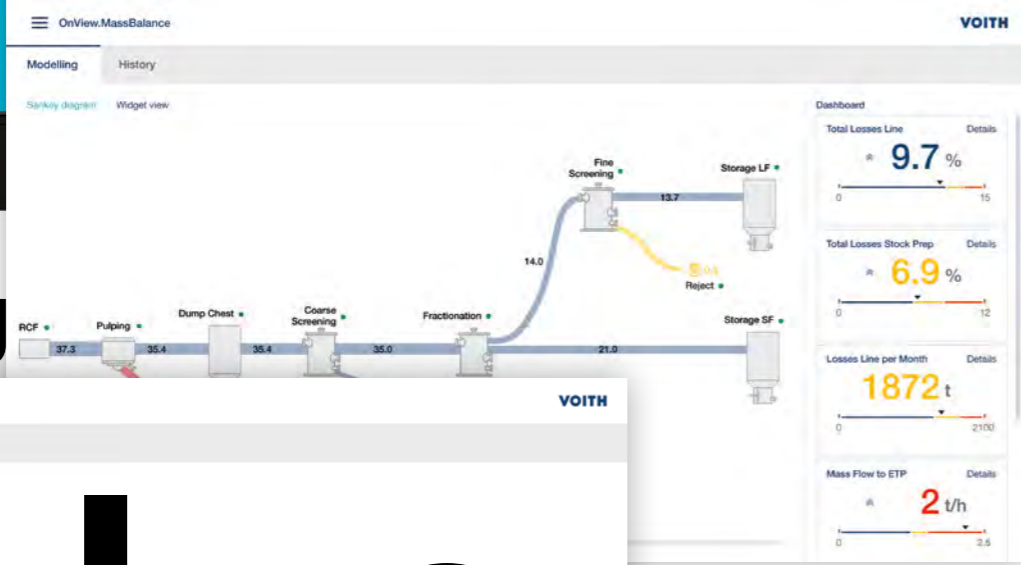

Value

These days, every paper machine generates a wealth of data. This is a real treasure trove when it comes to making the papermaking process more efficient, stable and cost-effective.

“When digital transformation is done right, it’s like a caterpillar turning into a butterfly,” said George Westerman, lecturer at the Massachusetts Institute of Technology’s (MIT) Sloan School of Management and one of the thought leaders on digital transformation, a few years ago. This is a philosophy that Voith has brought to life with its Papermaking 4.0 concept. In this context, the cloud platform OnCumulus forms a key element of this philosophy. It is the result of a vision in which data is not simply collected but also transformed with digital tools to give paper manufacturers completely new ways of boosting the efficiency of their production processes.

“Simply presenting the data visually in an easy-to-understand format can already significantly simplify day-to-day work and reveal optimization potentials,” says Maria Knauer, Global Product Manager Efficiency Solutions at Voith. For this purpose, Voith has developed apps such as Analyzer, Cockpit, Events and Functions. Together, they form OnCumulus.Suite, the foundation of any OnCumulus installation. Each of these apps serves a specific purpose. Analyzer, for example, presents live and historical data in graphical form. Other apps can be used to calculate KPIs, display complex processes in an easy-to-understand format, or identify and show areas in the process where defined thresholds for warnings or alarms have been exceeded, thus enabling rapid troubleshooting. “All of the apps can be easily configured and customized by each user according to their needs,” Knauer explains.

OnCumulus is also a data hub. After all, paper machines generate an enormous amount of data every day, and it is often difficult for even the most experienced paper technologists to identify the interrelationships between the information. The apps of the OnView and OnEfficiency families leverage this data, bringing the full power of the OnCumulus concept to bear. In this context, OnView is all about the intelligent visualization of data. In most cases, the

Based on stock consistency and flow measurements (→ p. 18), OnView.MassBalance enables live calculation and display of all relevant losses – a first step towards autonomous stock preparation (→ p. 38).

from Data

data is shown together with specific recommended actions aimed at optimizing processes. This is the case, for example, with OnView.MassBalance. To put it simply, the app calculates a mass balance over the entire line and displays live data on losses at all relevant points. “If a defined threshold is exceeded, operators receive recommended actions explaining how to reduce the loss,” adds Knauer. “This makes it possible to save a significant amount of fiber – since the price of recycled paper is currently extremely high, this can quickly translate into savings of several hundred thousand euros a year.”

The solutions offered as part of the OnEfficiency family go one step further in the direction of increasing efficiency and cutting costs. OnEfficiency.BreakProtect, for example, uses its unique AI capabilities in combination with Voith’s process knowledge to identify, understand and prevent causes of breaks. It is already being used by several customers and delivering promising results.

Going Creating

Smooth Rolling in Pulp Machines

Conventional roll covers often disrupt operations due to their rapid wear. They cause high specific pressures and produce a short nip. This can be prevented with a new roll cover from Voith.

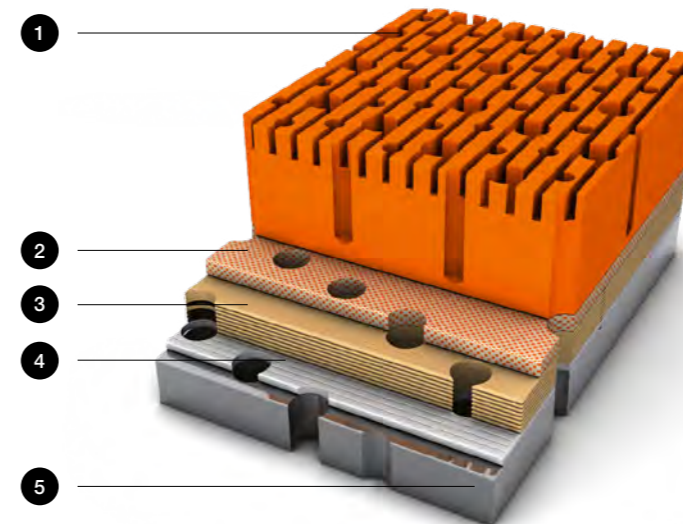

- 1 Functional polyurethane layer
- 2 WebNet
- 3 Multilayer base
- 4 Interface
- 5 Steel roll

IntensePress is available in four different versions: smooth, blind-drilled, grooved, and blind-drilled and grooved. In addition to the suction holes, IntenseFlow is available in three versions: blind-drilled, grooved, and blind-drilled and grooved.

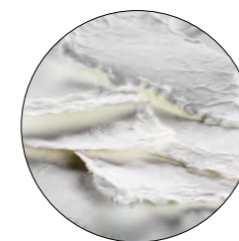

The new IntensePress PU roll cover simplifies pulp production and thus increases the productivity of the line.

The IntensePress roll cover has been specially designed for demanding use on press rolls in pulp machines and twin wire presses. These roll covers are made from polyurethane (PU), an extremely durable material that exhibits high chemical and thermal resistance, both of which increase the service life of the roll and simplify workflows. For each customer, the cover is individually modified in order to achieve the ideal nip load depending on the operation.

“Unlike conventional PU covers, IntensePress has been proven to perform reliably in a pulp machine’s critical chemical environment,” reports a satisfied Chinese pulp mill customer. In addition, IntensePress increased the service life of the forming fabrics from one to two months, resulting in less downtime and lower operating costs. IntensePress’ performance was also highly praised at Södra Cell Mösterås pulp mill. Here, the new cover prevented the roller from polygonizing, as it maintained its strength over the entire service life. The test run showed that the cover could increase the service life of the roll from between eight and 10 months to between 12 and 18 months.

IntensePress can be used with all standard machines currently on the market. A version of the roll cover specially adapted for use in suction press rolls is also available under the name IntenseFlow.

+Pro, +Peak and +Up – the plus sign in Voith’s product family for press felts stands for increased efficiency. In this context, the three modular Add-Ons address different requirements in paper production.



The Efficiency Add-Ons for press felts from Voith have already proven to be extremely effective in increasing a paper machine’s efficiency in numerous applications. This is because the modular product enhancements shorten start-up times, extend life cycles, and reduce felt wear. The newest member of the family is +Pro. The purpose of this recent development, which is compatible with all Voith press felts, is to achieve a smoother paper surface and therefore improve the printability of the material for the customer. The basis for this is the exceptionally even surface of the press felt.

Another advantage of +Pro is that the Add-On distributes the pressure evenly over the entire felt, thereby increasing dryness and reducing the risk of sheet breaks. Ultimately, this means less time-consuming unplanned machine downtime and thus cost benefits. At the same time, the more even pressure distribution results in more stable running conditions, thereby reducing wear on the press felt and extending the felt cycle.

+Peak offers a different approach to increasing efficiency. Due to the elastomer material incorporated into the felt, the Add-On compresses significantly more than a standard felt under the same load, which allows the felt to reach its full potential more quickly. In customer operations, +Peak has been shown to make the felt more resilient than conventional products throughout felt life, exhibiting consistently superior per-



formance and enhanced dewatering capacity. The latter helps to increase the dry content of the paper web and thus reduce steam consumption, which in turn reduces energy consumption.

+Up is an Add-On specially optimized for the requirements of tissue production that speeds up the start-up process. Demonstrated in customer use, +Up has shown to improve the machine’s full capacity available up to 50 percent faster. The higher saturation capability at start-up provides a more stable and faster available output, which means higher overall productivity over the life of a felt cycle.

“Efficiency Add-Ons such as +Peak and +Up have already paved the way for more efficient and sustainable production processes worldwide,” says Anne Klaschka, Global Product Manager Press Section at Voith. “Adding +Pro to this family offers customers an additional tool that also helps enhance the quality of the final products for our customers’ benefit.”

A+

for Greater Efficiency

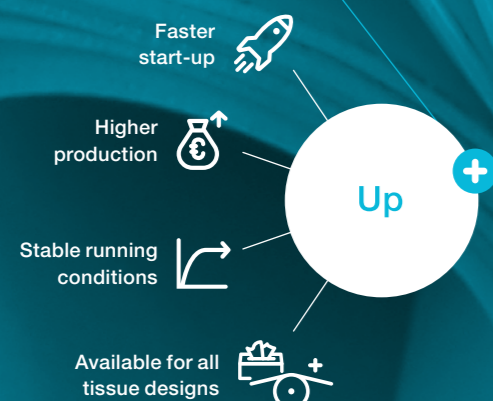

The goal is set:

Cepi, the Confederation of European Paper Industries, is convinced that the paper industry can contribute to reaching European climate neutrality by 2050. Małgosia Rybak, Cepi’s Climate Change & Energy Director, in Brussels, Belgium, goes in-depth about how.

The Cepi 2050 roadmap is well known in the industry. How do you rate the current status of the European paper industry with respect to fulfilling decarbonization targets?

The pulp and paper industry already achieved a 29 percent reduction of carbon emissions from 2005 to date, making our sector’s direct emissions accountable for less than 0.7 percent of total EU greenhouse gases (GHG) emissions: a leading performance amongst industrial sectors. Yet our industry is committed to doing even better.

From your point of view, which measures will be most important to achieve these targets?

With an even more ambitious target of 55 percent GHG emission reduction by 2030, our adjusted industry strategy must be combined with the right regulatory framework and the necessary financial support for sustainable solutions. With substantial support from the EU, the already ambitious targets set by our industry could potentially be exceeded.

What role do you think process electrification and other power-to-heat technologies will play in the industry’s decarbonization efforts?

An increased role of electricity in paper mills is to be expected. Process electrification is one of the technology options to reduce our industry’s emissions. The replacement or adjustment of the traditional drying equipment with a combined drying and heat integration innovation may result in energy savings at the mill level. Electricity-based technologies in dewatering and drying may also lead to increased energy efficiency. In the near future, however, full electrification of paper mills does not seem to be economically viable without sufficient competitively priced renewable electricity.

How does Cepi expect CO₂ prices to develop over the next decade?

At the moment, our industry is facing a review of key policy instruments driving the carbon price, such as the Emission Trading System (ETS) Directive. The European Commission has been assessing different scenarios, applying different parameters, also in the context of various international ambitions. For our industry, the ETS contains provisions for free allocation and the possibility of compensation for indirect carbon costs at the national level. We need policy stability and predictability to keep our industry competitive at the international level.

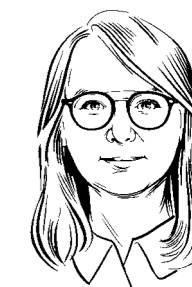

Małgosia Rybak, Climate Change & Energy Director at Cepi

The best way
to predict

Peter Drucker,
Educator and Author

the future is
to create it.

VOITH

